

2014/2/8 第18回オープンCAE勉強会@富山
2014/2/15 第28回オープンCAE勉強会@岐阜

OpenFOAM

標準チュートリアル/Allrun 「やってみた」の紹介

オープンCAEコンサルタント
OCSE^2 代表 野村悦治

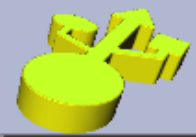



E. Mogura

1月11日

@mogura77x

OpenFOAMのext版がfoam-extend-3.0という形でリリースされた。なんとかコンパイル出来たので、早速tutorialsのAllrunを開始した。さて、いつになったら終わるやら。正規版（約300時間）より長くなるのはほぼ確実だろうな。

開く

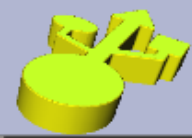

	OpenFOAM Ver.	
	2.2.x	ext(3.0)
チュートリアル数	170	202
総計算時間 (Hr)	243.6	464.3
ディスクスペース(GB)	174	437

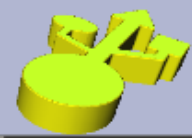

	OpenFOAM Ver.	
	2.2.x	ext(3.0)
チュートリアル数	170	202
総計算時間 (Hr)	243.6	464.3
ディスクスペース(GB)	174	437

Category	OpenFOAM Ver.	
	2.2.x	ext(3.0)
DNS	1	1
basic	4	12
combustion	12	8
compressible	23	24
coupled		3
discreteMethods	7	7
electromagnetics	2	2
equationReader		1
financial	1	1
heatTransfer	16	11
incompressible	40	39
lagrangian	14	7
mesh	3	2
multiSolver		1
multiphase	45	28
solidMechanics		35
stressAnalysis	2	
surfaceTracking		7
viscoelastic		13

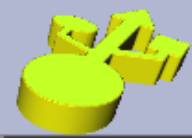

foam-extend(Build :3.0-8d34057e525d)				CPU: Core-i7 950(3.06GHz)			数字は推定 (ログがないので)					
Solver/case の青字はext版固有				Memory: 24GB			数字は手動計算やり直し					
				OS: Linux Mint13(Ubuntu-12.04)			数字は計算が異常終了					
No	Category	Solver	model	case	nPoints	nCells	diskUsage(kB)	ExecutionTime	ClockTime			
1	DNS	dnsFoam		boxTurb16	4,913	4,096	20,328	7.25	7	blockMesh	boxTurb	
2	basic	PODSolver		1DPODiffusion	204	50	540	0.00	0	blockMesh	scalarTran	
3				1DPODsin	204	50	632	0.00	0	blockMesh	scalarTran	
4				Case1.1_mixingPlane_sec	107837	105000	4196	0	0			
5		laplacianFoam		flange	7,189	5,712	27,368	4.01	4	AnsysToFoam	\$applicati	
6				twoBlocksMixingPlane	484	200	124		0			
7				twoBlocksMixingPlaneMis	330	130	1,120		0			
8		potentialFoam		cylinder	4,222	2,000	1,096	0.04	0	blockMesh	\$applicati	
9				pitzDaily	25,012	12,225	3,512	0.22	1	blockMesh	\$applicati	
10		scalarTransportFoam		pitzDaily	25,012	12,225	19,368		12	blockMesh	\$applicati	
11				swirlTest	1,722	800	496		0	blockMesh	\$applicati	
12			sixDOFSolver		sixDOFmotion			1,224	0.38	0	\$application	
13				springDamper			608	0.16	0	\$application		
14		combustion	XiFoam	les	pitzDaily	25,012	12,225	225,508	4,371.59	4,379	blockMesh	\$applicati
15					pitzDaily3D	262,626	244,500	32,608,204	164,692.00	164,937	blockMesh	\$applicati
16	ras			moriyoshiHomogeneous	5,112	2,450	22,728	19.57	20	blockMesh	\$applicati	
17					moriyoshiHomogeneousP	5,112	2,450	23,316	20.50	20	cloneCase	setControl
18			dieselFoam		aachenBomb	178,164	168,100	672,652	4,199.09	4,203	blockMesh	\$applicati
19	engineFoam			kivaTest	30,742	27,544		321.22	321	controlDict.2nd	\$applicati	
19					kivaTest	30,742	27,544	214,176		error	kivaToFoam	\$applicati
20	fireFoam			smallPoolFire2D	45,602	22,500	228,852	2,721.12	2,725	blockMesh	topoSet	
21	reactingFoam	ras		counterFlowFlame2D	8,282	4,000	13,644	185.26	186	blockMesh	\$applicati	
22	rhoCentralFoam			LadenburgJet60psi	2,501	1,200	12,824	112.07	112	blockMesh	\$applicati	
23				biconic25-55Run35	65,408	32,385	20,516	89.22	90	blockMesh	datToFoar	
24				forwardStep	32,898	16,128	34,248	313.98	314	blockMesh	\$applicati	
25				obliqueShock	3,782	1,800	3,428	20.10	20	blockMesh	\$applicati	
26				shockTube	404	100	400	0.18	1	blockMesh	setFields	
27				wedge15Ma5	9,922	4,800	3,536	22.33	22	blockMesh	\$applicati	
28		rhoPimpleFoam	ras		angledDuct	24,696	22,000	7,148	73.86	74	m4	blockMesh
29		rhoPisoFoam	les		pitzDaily	25,012	12,225	35,382,548	60,498.80	60,738	blockMesh	\$applicati
30	ras			cavity	882	400	1,220	0.44	1	blockMesh	\$applicati	
31	rhoPorousMRFPimpleFoam			mixerVessel2D	6,582	3,072	7,744	23.29	23	makeMesh	\$applicati	
32				angledDuctExplicit	24,696	22,000	31,428	97.06	97	m4	blockMesh	
33				angledDuctImplicit	24,696	22,000	28,652	10.82	11	m4	blockMesh	
34				heaver.Joseph	8,282	4,000	4,028	1.46	1	blockMesh	\$applicati	

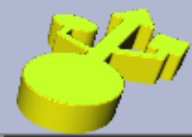

特記事項

❑ Allrun が動かなかったもの（手動実行）

reactingFoam/ras/counterFlowFlame2D
rhoPisoFoam/les/pitzDaily
sonicFoam/laminar/forwardStep
sonicFoam/ras/prism
boundaryFoam/boundaryWallFunctions
pimpleDyMFoam/wingMotion2D_pimpleDyMFoam
porousExplicitSourceReactingParcelFoam/parcelInBox

solidEquilibriumDisplacementFoam/beamEndLoad

❑ 計算が異常終了

engineFoam/kivaTest
icoDyMFoam/movingConeTopo
icoFoam/mixingPlane
pimpleDyMFoam/wingMotion2D_pimpleDyMFoam
interDyMFoam/damBreakWithObstacle
interDyMFoam/sloshingTank3D
interDyMFoam/sloshingTank3D3DoF
settlingFoam/ras/dahl
elasticNonLinTlSolidFoam/nonLinBlock

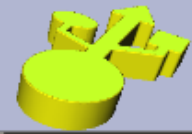



OpenFOAM 全チュートリアル Allrun をやってみた

No	Category	Solver	model	caseName	nPoints	nCells	diskUsage(kB)	ExecutionTim	ClockTime		
OpenFOAM-2.2.x(Build : 2.2.x-54530cc7e8eb) (但し、一部、2.2.0 にて計算)⇒赤字部分				CPU: Core-i7 950(3.06GHz) Memory: 24GB		数字は推定(ログがないので) 数字はOF-2.2.0にて計算したもの					
OS: Linux Mint13(Ubuntu-12.04)											
1	DNS	dnsFoam		boxTurb16	4,913	4,096	16,466	7.07	7		
2	basic	laplacianFoam		flange	7,189	5,712	31,373	3.83	4		
3		potentialFoam		cylinder	4,222	2,000	8,204	0.06	9		
4		pitzDaily		pitzDaily	25,012	12,225	3,433	0.23	0		
5		scalarTransportFoam		pitzDaily	25,012	12,225	19,124	0.00	0		
6	combustion	PDRFoam		flamePropagationWithObstacles	8,808	8,025	43,242	312.29	312		
7		XiFoam	ras	moriyoshiHomogeneous	5,112	2,450	22,812	34.94	36		
8				moriyoshiHomogeneousPart2	5,112	2,450	23,848	37.22	37		
9				gri			5,618	3.53	4		
10				h2			450	0.04	0		
11			chemFoam		ic8h18			158,002	2,560.57	2,563	
12					nc7h16			52,134	268.99	270	
13			engineFoam		kivaTest	30,742	27,544		242.96	245	
14					oppositeBurningPanels	155,188	143,040	7,105,082	6,301.44	9,484	
15			fireFoam	les	smallPoolFire2D	45,602	22,500	240,913	2,074.26	2,078	
16				smallPoolFire3D	226,981	216,000	160,025	420.04	422		
17		reactingFoam	ras	counterFlowFlame2D	8,282	4,000	8,341	122.62	123		
18	compressible	rhoCentralFoam		LadenburgJet60psi	2,501	1,200	1,353	8.28	8		
19				biconic25-55Run35	65,408	32,385	20,254	44.95	45		
20				forwardStep	32,898	16,128	34,440	335.45	337		
21				obliqueShock	3,782	1,800	3,300	20.25	20		
22				shockTube	404	100	309	0.17	0		
23				wedge15Ma5	9,922	4,800	3,536	21.64	22		
24				rhoLTSPimpleFoam		angledDuct	24,696	22,000	35,929	49.24	50
25				rhoPimpleDyMFoam		annularThermalMixer				29.02	29
26							117,473	83,098	1,823,070	5,250.48	5,257
27						les	pitzDaily	25,012	12,225	1,088,836	3,039.02
28		rhoPimpleFoam	ras	angledDuct	24,696	22,000	6,797	46.58	46		
29				cavity	882	400	1,140	0.38	0		
30		rhoPimplecFoam		mixerVessel2D	6,528	3,072	7,357	35.91	36		
31		rhoPorousSimpleFoam		angledDuct	24,696	22,000	6,877	57.30	57		
32				angledDuctExplicit	24,696	22,000	18,502	50.55	51		
				angledDuctImplicit	24,696	22,000	17,781	5.63	6		

したが、せっかくなのでログファイルの解析(というほどのこともない整理)結果を公開することにした。⇒詳細シートは[こちら](#)

No	Category	Solver	model	case	nPoints	nCells	diskUsage(kB)	ExecutionTime
181	solidMechanics	icoFsiElasticNonLinULSolidFoam		HronTurekFsi	43,630	21,268	312,793,008	603,676
15	combustion	XiFoam	les	pitzDaily3D	262,626	244,500	32,608,204	164,692
124	multiphase	cavitatingFoam	les	throttle3D	1,551,171	1,479,900	6,011,224	104,887
142	multiphase	multiphaseInterFoam	laminar	damBreak4phaseFine	69,174	34,200	1,029,192	104,407
149	solidMechanics	icoFsiFoam		flappingConsoleSmall	11,184	5,350	6,830,788	71,322
199	viscoelastic	viscoelasticFluidFoam		S-MDCPP	45,842	22,500	468,780	63,883
42	compressible	sonicFoam	ras	nacaAirfoil	80,860	40,000	535,820	62,233
29	compressible	rhoPisoFoam	les	pitzDaily	25,012	12,225	35,382,548	60,499
55	discreteMethods	mdFoam		nanoNozzle	30,923	27,136	4,111,460	53,039
187	surfaceTracking	interTrackFoam		tank3D	42,025	38,400	2,815,612	37,367
191	viscoelastic	viscoelasticFluidFoam		FENE-CR	39,161	35,000	145,560	36,378
127	multiphase	compressibleInterFoam		depthCharge3D	1,056,321	1,024,000	7,829,052	23,611
144	multiphase	settlingFoam	ras	tank3D	23,044	19,166	296,100	23,476
125	multiphase	cavitatingFoam	ras	throttle	59,062	28,770	206,704	23,388
201	viscoelastic	viscoelasticFluidFoam		XPP_DE	45,842	22,500	501,900	22,646
195	viscoelastic	viscoelasticFluidFoam		Leonov	42,122	20,700	199,104	20,867
192	viscoelastic	viscoelasticFluidFoam		FENE-P	42,122	20,700	194,656	20,228
198	viscoelastic	viscoelasticFluidFoam		PTT-Linear	42,122	20,700	196,512	18,403
196	viscoelastic	viscoelasticFluidFoam		Oldroyd-B	42,122	20,700	127,388	17,612

+	☰	(ext-3) ▾	Diff(22x vs ext3) ▾	DiskUsage(22x) ▾	ExeTime(22x) ▾	ExeTime(ext-3) ▾	DiskUsage(ext-3) ▾	RawData(22x) ▾	R
---	---	-----------	---------------------	------------------	----------------	------------------	--------------------	----------------	---



2.2.x



ext-3

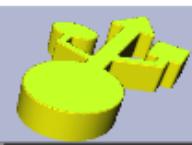

Category	Solver	model	case	nPoints	nCells	diskUsage(kB)	ExecutionTime
solidMechanics	icoFsiElasticNonLinULSolidFoam		HronTurekFsi	43,630	21,268	312,793,008	603,676
combustion	XiFoam	les	pitzDaily3D	262,626	244,500	32,608,204	164,692
multiphase	cavitatingFoam	les	throttle3D	1,551,171	1,479,900	6,011,224	104,887
multiphase	multiphaseInterFoam	laminar	damBreak4phaseFine	69,174	34,200	1,029,192	104,407
solidMechanics	icoFsiFoam		flappingConsoleSmall	11,184	5,350	6,830,788	71,322
viscoelastic	viscoelasticFluidFoam		S-MDCPP	45,842	22,500	468,780	63,883
compressible	sonicFoam	ras	nacaAirfoil	80,860	40,000	535,820	62,233
compressible	rhoPisoFoam	les	pitzDaily	25,012	12,225	35,382,548	60,499
discreteMethods	mdFoam		nanoNozzle	30,923	27,136	4,111,460	53,039
surfaceTracking	interTrackFoam		tank3D	42,025	38,400	2,815,612	37,367
viscoelastic	viscoelasticFluidFoam		FENE-CR	39,161	35,000	145,560	36,378
multiphase	compressibleInterFoam		depthCharge3D	1,056,321	1,024,000	7,829,052	23,611
						296,100	23,476
						206,704	23,388
						501,900	22,646
						199,104	20,867

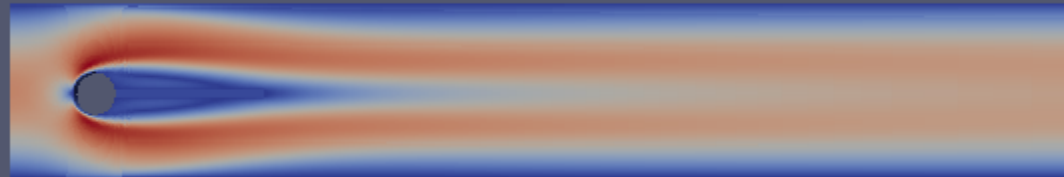

Time: 40

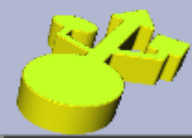
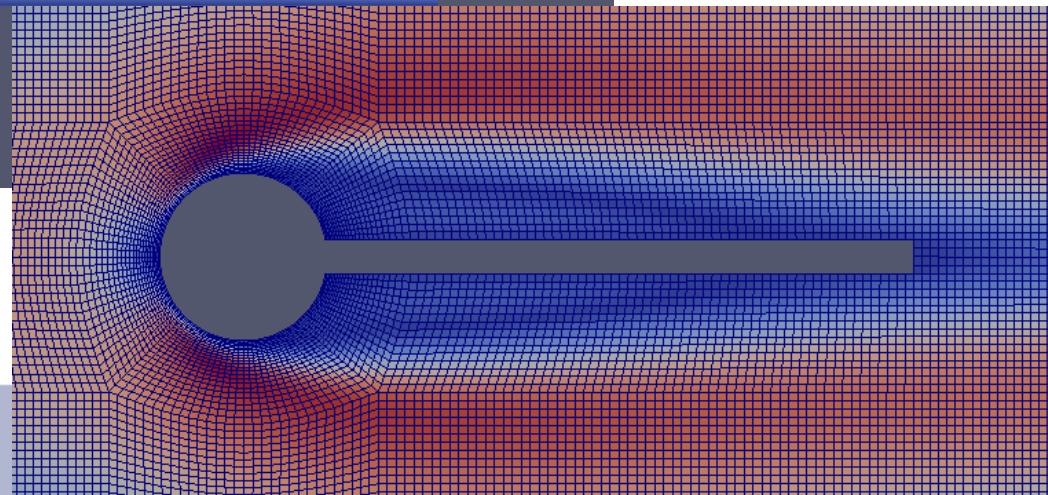

1	No	Category	Solver	model	case	nPoints	nCells	diskUsage	ExecutionTim	ClockTime	Exe-2.2.x	Exe-3.0-ext
167	149	multiphase	interFoam	ras	damBreakFine	15,774	7,700	19,916	31.82	33	31.82	30.39
168	136	multiphase	interFoam	laminar	damBreakFine	15,774	7,700	15,060	18.15	18		
169	139	multiphase	interFoam	ras	damBreakFine	15,774	7,700	20,416	30.39	31		
170	147	multiphase	interFoam	les	nozzleFlow2D	41,707	20,603	137,741	2,085.90	2,089	2,085.90	3,317.35
171	137	multiphase	interFoam	les	nozzleFlow2D	41,707	20,603	116,236	3,317.35	3,322		
172	153	multiphase	interMixingFoam	laminar	damBreak	4,746	2,268	6,603	26.91	27	26.91	22.97
173	140	multiphase	interMixingFoam	laminar	damBreak	4,746	2,268	6,220	22.97	23		
174	125	multiphase	MRFInterFoam		mixerVessel2D	6,528	3,072	10,721	20.41	21	20.41	14.41
175	120	multiphase	MRFInterFoam		mixerVessel2D	6,528	3,072	9,040	14.41	15		
176	160	multiphase	multiphaseInterFoam	laminar	damBreak4phase	4,746	2,268	41,569	146.87	147	146.87	1,187.05
177	141	multiphase	multiphaseInterFoam	laminar	damBreak4phase	4,746	2,268	117,668	1,187.05	1,189		
178	161	multiphase	multiphaseInterFoam	laminar	damBreak4phaseFine	69,174	34,200	4,888,473	3,848.19	3,907	3,848.19	104,407.00
179	142	multiphase	multiphaseInterFoam	laminar	damBreak4phaseFine	69,174	34,200	1,029,192	104,407.00	104,571		
180	162	multiphase	settlingFoam	ras	dahl	16,482	8,000	638,648	10,188.50	10,221		
181	143	multiphase	settlingFoam	ras	dahl	16,482	8,000	80,392	585.37	587		
182	163	multiphase	settlingFoam	ras	tank3D	23,044	19,166	307,693	19,861.50	19,885	19,861.50	23,475.60
183	144	multiphase	settlingFoam	ras	tank3D	23,044	19,166	296,100	23,475.60	23,505		
184	166	multiphase	twoPhaseEulerFoam		be2	12,462	6,000	394,752	306.19	309	306.19	364.46
185	146	multiphase	twoPhaseEulerFoam		be2	12,462	6,000	365,672	364.46	366		
186	165	multiphase	twoPhaseEulerFoam		bed	6,552	3,125	94,240	376.17	379	376.17	93.16
187	145	multiphase	twoPhaseEulerFoam		bed	6,552	3,125	82,792	93.16	94		
188	167	multiphase	twoPhaseEulerFoam		bubbleColumn	3,952	1,875	29,724	173.58	175	173.58	169.37
189	147	multiphase	twoPhaseEulerFoam		bubbleColumn	3,952	1,875	30,096	169.37	171		

一番下に 20 行 追加

+ SummaryAll Summary(22x) Summary(ext-3) Diff(22x vs ext3) DiskUsage(22x) ExeTime(22x) E>

正規版(2.2.x)とExt(3.0)版で、
同一チュートリアルが94ケース存在

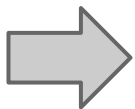

計算時間比較

No	Category	Solver	model	case	
167	149	multiphase	interFoam	ras	damBreakFine
168	136	multiphase	interFoam	laminar	damBreakFine
169	139	multiphase	interFoam	ras	damBreakFine
170	147	multiphase	interFoam	les	nozzleFlow2D
171	137	multiphase	interFoam	les	nozzleFlow2D
172	153	multiphase	interMixingFoam	laminar	damBreak
173	140	multiphase	interMixingFoam	laminar	damBreak
174	125	multiphase	MRFInterFoam		mixerVessel2D
175	120	multiphase	MRFInterFoam		mixerVessel2D
176	160	multiphase	multiphaseInterFoam	laminar	damBreak4phase
177	141	multiphase	multiphaseInterFoam	laminar	damBreak4phase
178	161	multiphase	multiphaseInterFoam	laminar	damBreak4phase
179	142	multiphase	multiphaseInterFoam	laminar	damBreak4phase

計算時間の比較

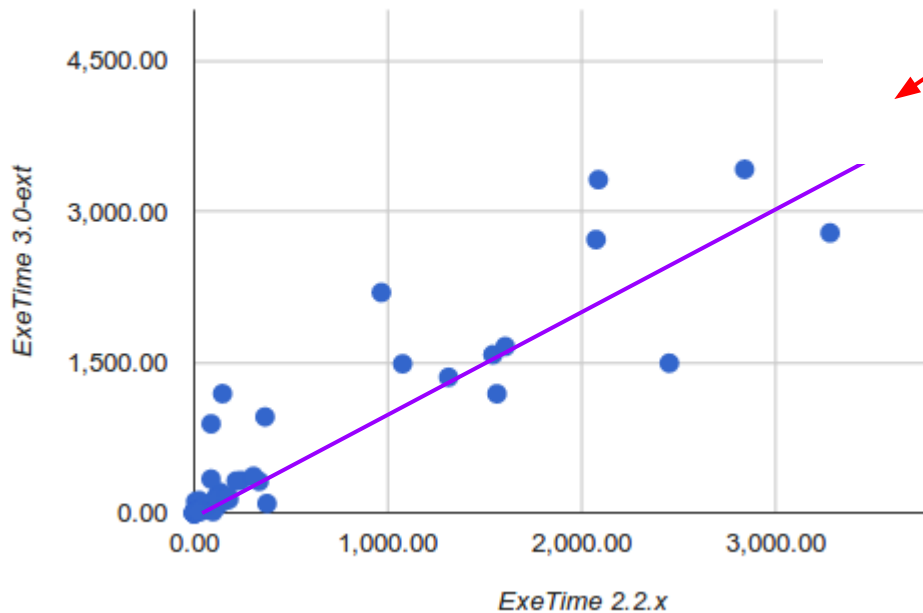

計算時間の比較

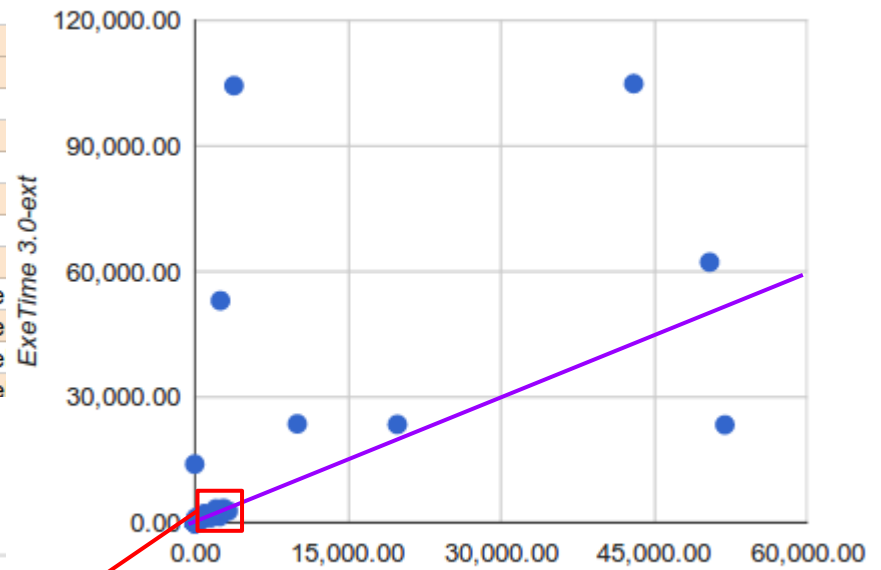

ExeTime 2.2.x

3,952	1,875	29,724	173.58	175	173.58	169.37
3,952	1,875	30,096	169.37	171		

3) DiskUsage(22x) ExeTime(22x) ExeTime(22x)

-3.0-ext

30.39

3,317.35

22.97

14.41

1,187.05

24,407.00

23,475.60

364.46

93.16

2.2.x

multiphase	cavitatingFoam	les	throttle3D	1,551,171	1,479,900	5,818,518	43,021.40	43,162
multiphase	cavitatingFoam	les	throttle3D	1,551,171	1,479,900	6,011,224	104,887.00	106,226

ext-3

ext-3

計算時間の比較

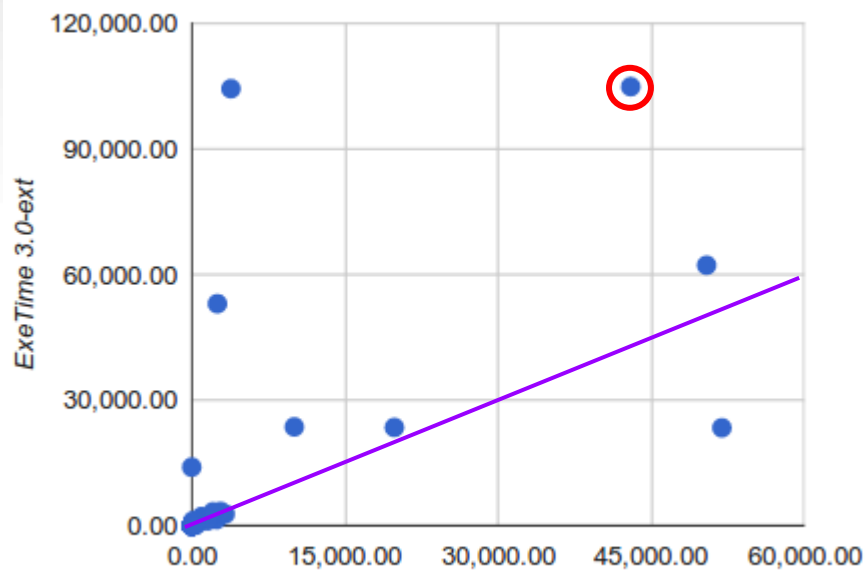

ExeTi

2.2.x

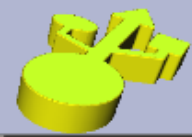

multiphase	cavitatingFoam	les	throttle3D	1,551,171	1,479,900	5,818,518	43,021.40	43,162
multiphase	cavitatingFoam	les	throttle3D	1,551,171	1,479,900	6,011,224	104,887.00	106,226

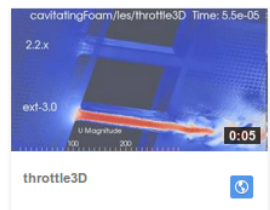
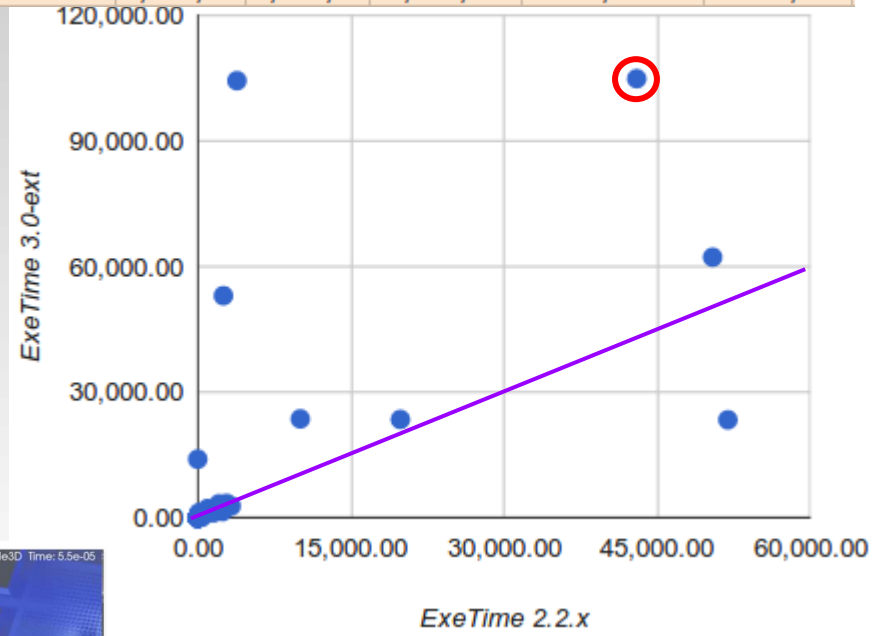
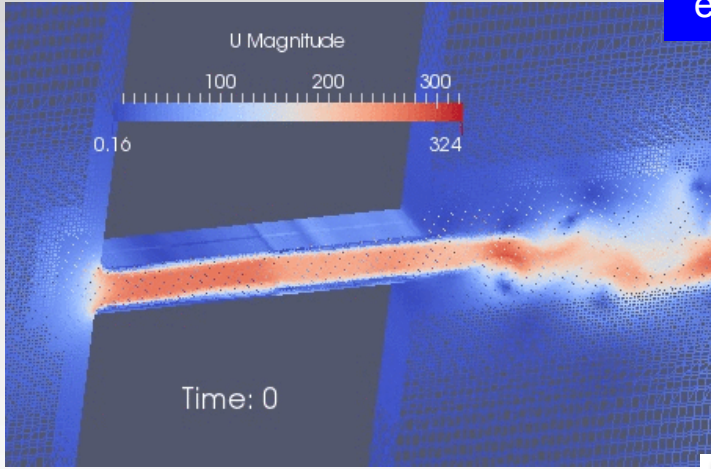

fvSolution

```

PISO
{
  nCorrectors 3;
  nNonOrthogonalCorrectors 0;
}

```

fvSchemes

```

divSchemes
{
  default none;
  div(phi,rho) Gauss limitedLinear_0.2;
  div(phi,U) Gauss filteredLinear2V_0.2_0;
  div(phi,k) Gauss filteredLinear2_0.2_0;
}

```

```

PIMPLE
{
  nCorrectors 3;
  nNonOrthogonalCorrectors 0;
}

```

```

divSchemes
{
  default none;
  div(phi,rho) Gauss vanLeer;
  div(phi,U) Gauss LUST_grad(U);
  div(phi,k) Gauss LUST_grad(k);
  div((muEff*dev(T(grad(U)))) Gauss

```

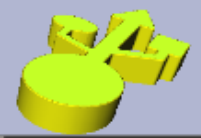
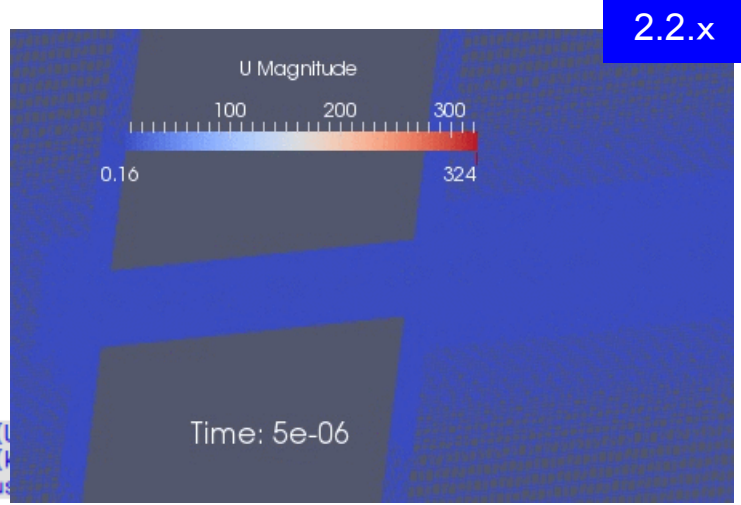

multiphase	cavitatingFoam	les	throttle	59,062	28,770	37,603	1,605.56	1,608
multiphase	cavitatingFoam	ras	throttle	59,062	28,770	536,485	51,953.90	52,032
multiphase	cavitatingFoam	les	throttle	59,062	28,770	36,320	1,656.34	1,658
multiphase	cavitatingFoam	ras	throttle	59,062	28,770	206,704	23,388.40	23,416

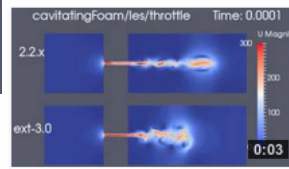
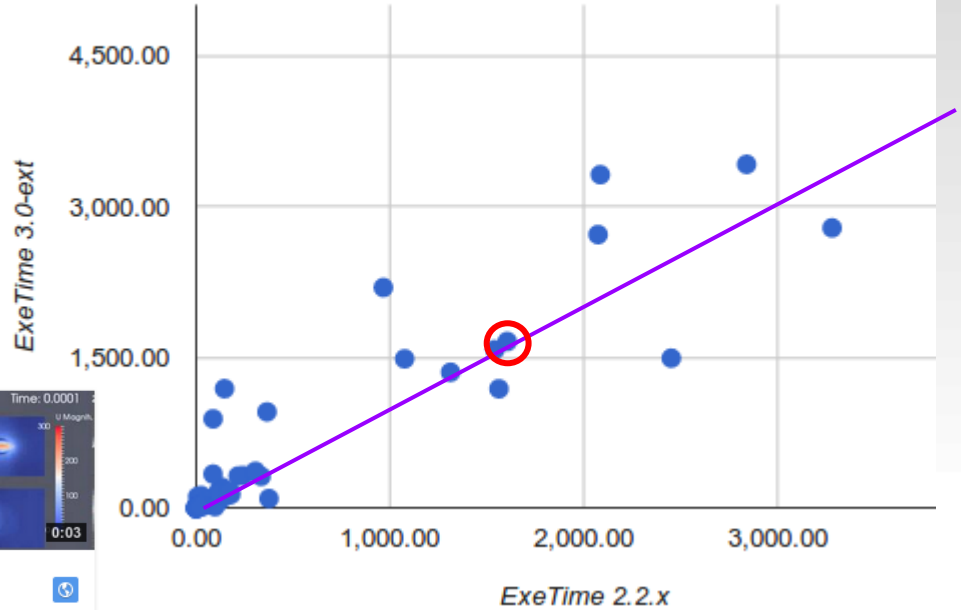
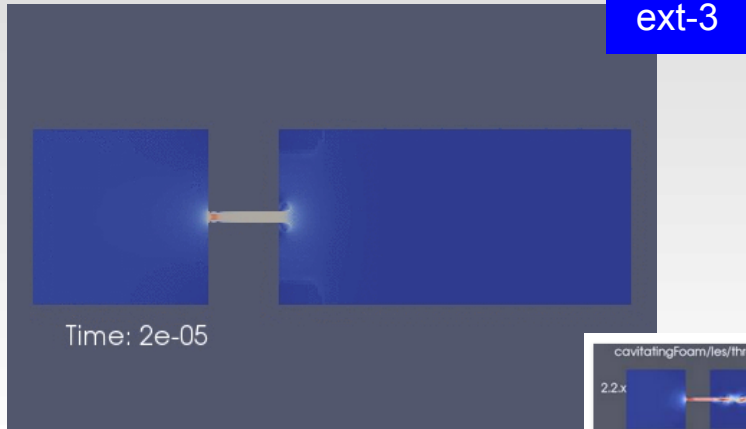

fvSolution

```
PISO
{
  nCorrectors 3;
  nNonOrthogonalCorrectors 0;
}
```

```
PIMPLE
{
  nCorrectors 3;
  nNonOrthogonalCorrectors 0;
}
```

fvSchemes

```
divSchemes
{
  default none;
  div(phi, rho) Gauss limitedLinear_0.2;
  div(phi, U) Gauss filteredLinear2V_0.2_0;
  div(phi, k) Gauss filteredLinear2_0.2_0;
}
```

```
divSchemes
{
  default none;
  div(phi, rho) Gauss vanLeer;
  div(phi, U) Gauss LUST_grad(U);
  div(phi, k) Gauss LUST_grad(k);
  div((muEff*dev(T(grad(U)))) Gauss linear
}
```

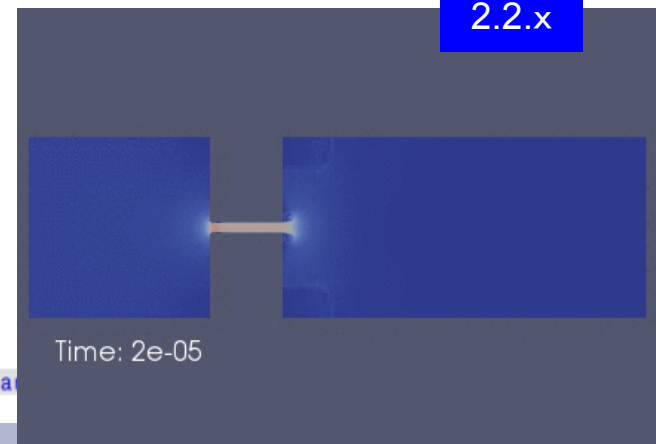

multiphase	cavitatingFoam	les	throttle	59,062	28,770	37,603	1,605.56	1,608
multiphase	cavitatingFoam	ras	throttle	59,062	28,770	536,485	51,953.90	52,032
multiphase	cavitatingFoam	les	throttle	59,062	28,770	36,320	1,656.34	1,658
multiphase	cavitatingFoam	ras	throttle	59,062	28,770	206,704	23,388.40	23,416

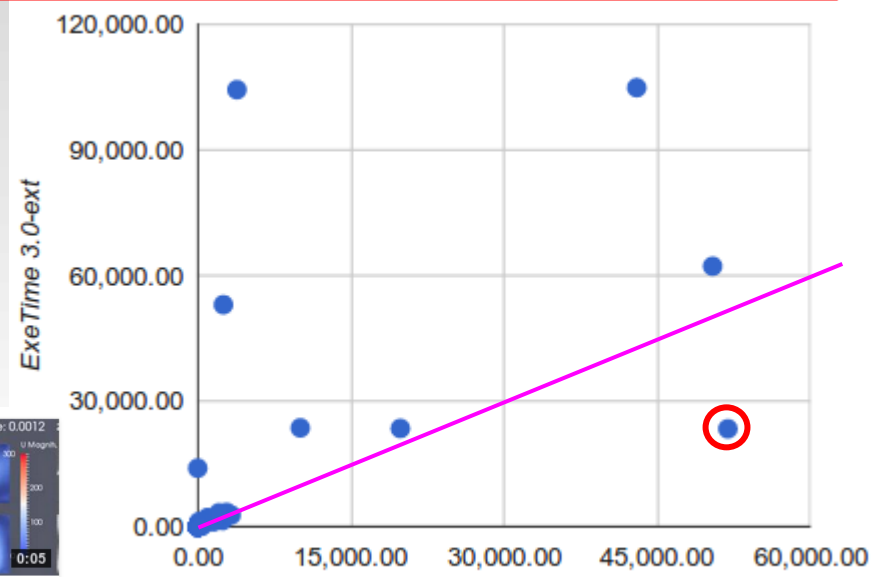
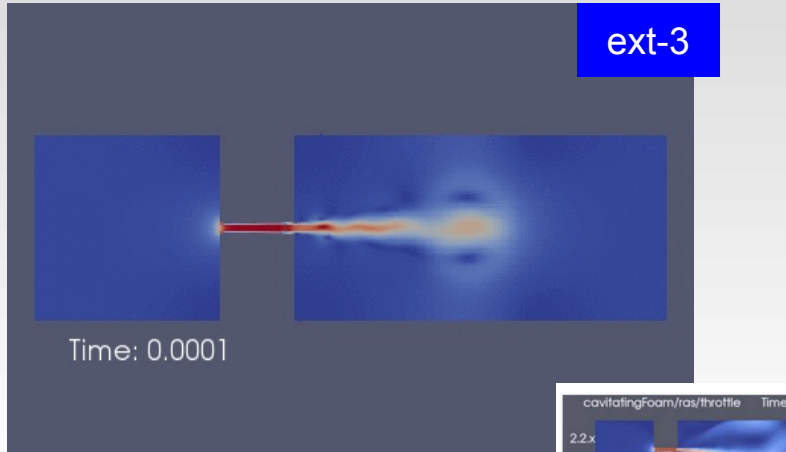

fvSolution



```
PISO
{
  nCorrectors 2;
  nNonOrthogonalCorrectors 1;
}
```



```
PIMPLE
{
  nCorrectors 3;
  nNonOrthogonalCorrectors 0;
}
```

fvSchemes



```
divSchemes
{
  default none;
  div(phi,v,rho) Gauss limitedLinear 0.2;
  div(phi,U) Gauss limitedLinearV 0.;
  div(phi,v,omega) Gauss upwind;
  div(phi,v,k) Gauss upwind;
}
```



```
divSchemes
{
  default none;
  div(phi,v,rho) Gauss limitedLinea
  div(phi,U) Gauss limitedLinea
  div(phi,v,omega) Gauss limitedLinea
  div(phi,v,k) Gauss limitedLinea
  div((muEff*dev(T(grad(U)))) Gauss
```

ExeTime 2.2.x

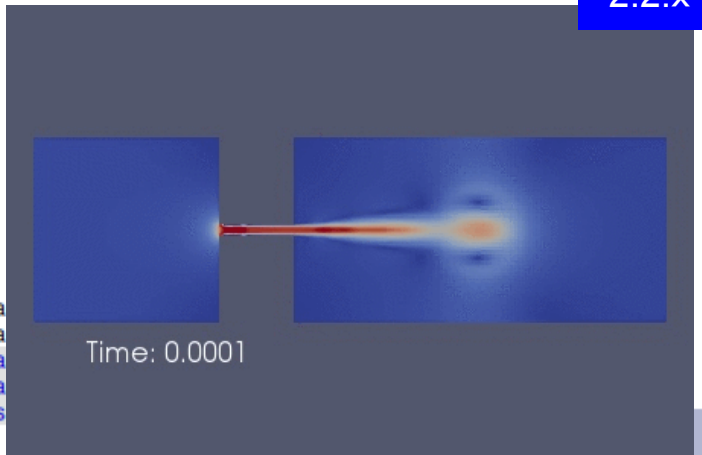

multiphase	multiphaseInterFoam	laminar	damBreak4phaseFine	69,174	34,200	4,888,473	3,848.19	3,907
multiphase	multiphaseInterFoam	laminar	damBreak4phaseFine	69,174	34,200	1,029,192	104,407.00	104,571

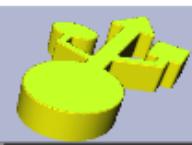
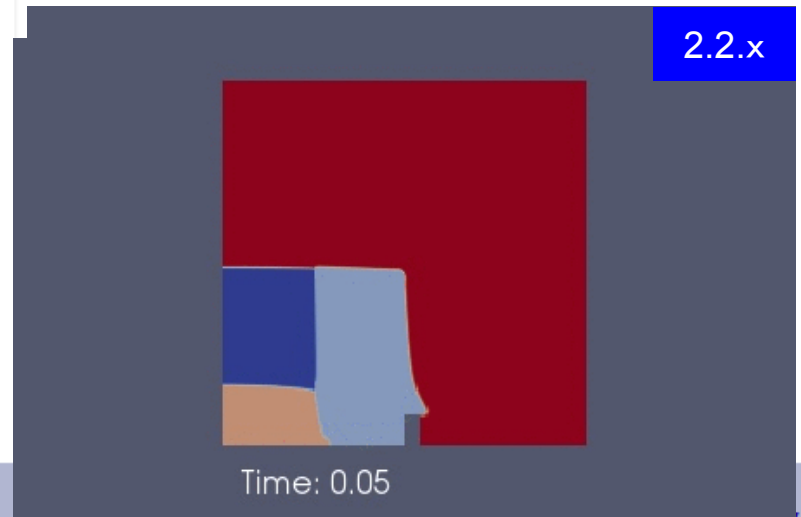
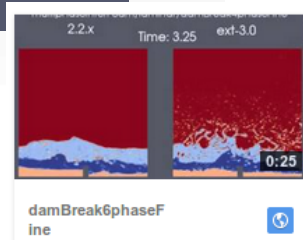
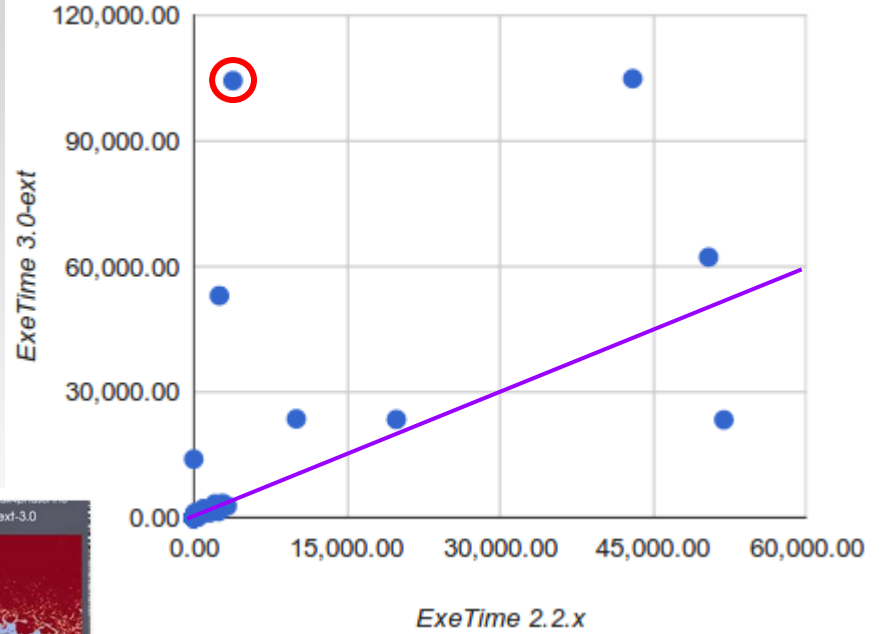
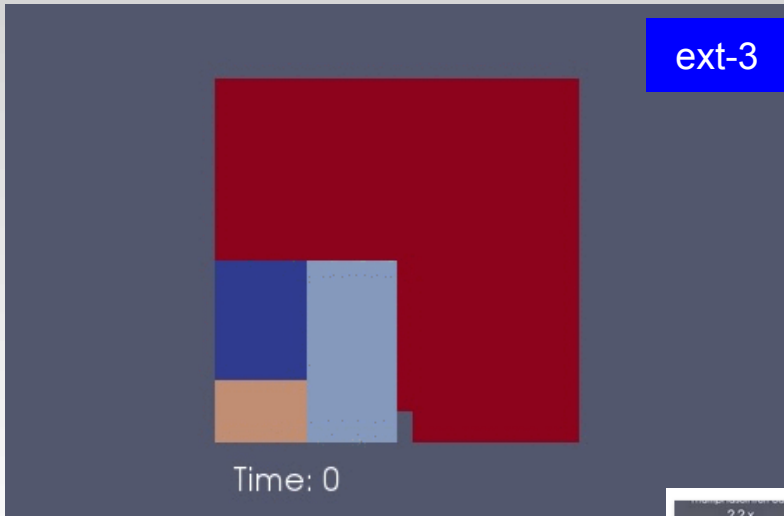

multiphase	multiphaseInterFoam	laminar	damBreak4phase	4,746	2,268	41,569	146.87	147
multiphase	multiphaseInterFoam	laminar	damBreak4phase	4,746	2,268	117,668	1,187.05	1,189

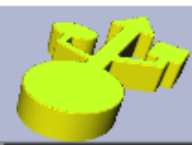
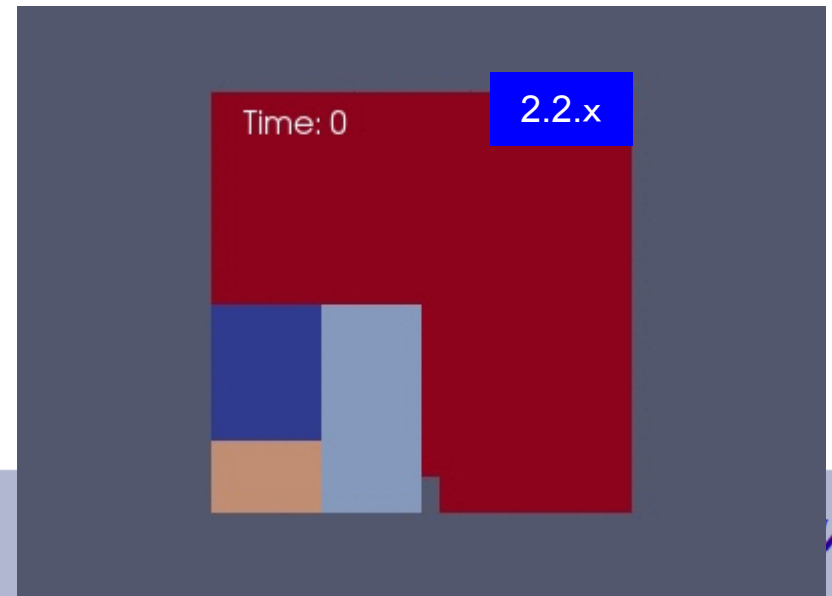
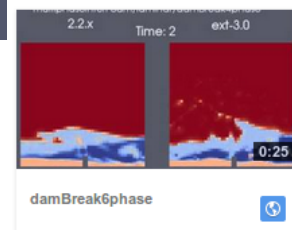
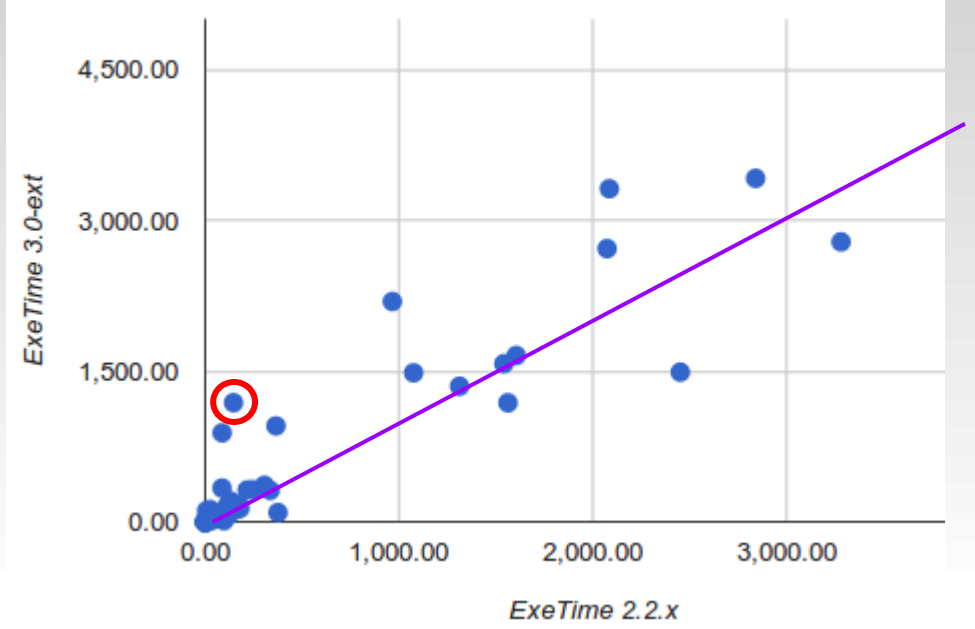
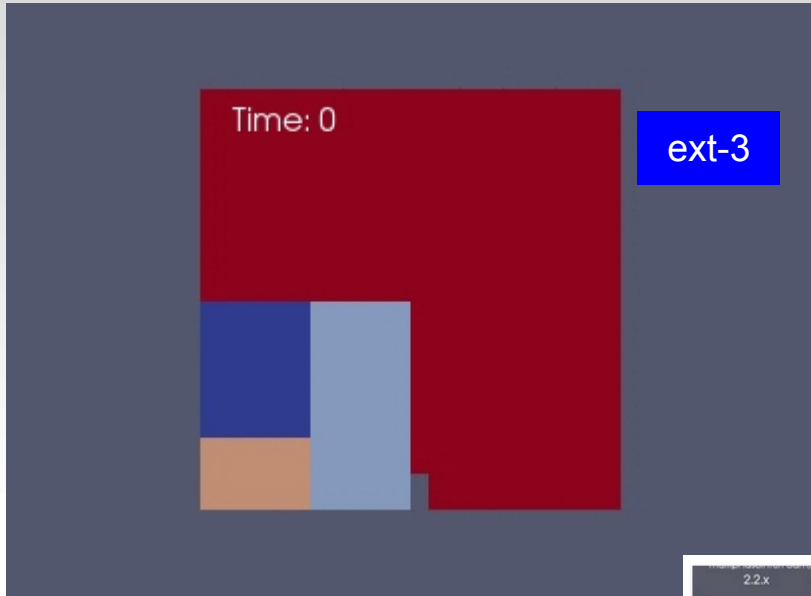

U

```

atmosphere
{
    type          fluxCorrectedVelocity;
    phi           phi;
    rho           rho;
    value         uniform (0 0 0);
}

```

```

atmosphere
{
    type          pressureInletOutletVelocity;

    value         uniform (0 0 0);
}

```

fvSchemes

```

divSchemes
{
    div(rho*phi,U) Gauss upwind;
    div(phi,alpha) Gauss limitedLimitedLinear_1_-1e-05_1.00001;
    div(phi*c,alpha) Gauss interfaceCompression;
}

```

```

divSchemes
{
    div(rho*phi,U) Gauss upwind;
    div(phi,alpha) Gauss vanLeer;
    div(phi*rb,alpha) Gauss interfaceCompression;
    div((muEff*dev(grad(U)))) Gauss linear;
}

```

```

fluxRequired
{
    default       yes;
}

```

```

fluxRequired
{
    default       no;
    pcorr;
    p_rgh;
    "alpha.*";
}

```

fvSolution

```

PISO
{
    nCorrectors     4;

    nNonOrthogonalCorrectors 0;
    nAlphaCorr     4;
    nAlphaSubCycles 4;
    cycleAlpha     yes;
    cAlpha         4;
}

```

```

PIMPLE
{
    momentumPredictor_no;
    nCorrectors     2;
    nNonOrthogonalCorrectors 0;

    nAlphaSubCycles 4;
    cAlpha         2;
}

```

discreteMethods	mdFoam		nanoNozzle	30,923	27,136	762,417	2,518.41	2,521
discreteMethods	mdFoam		nanoNozzle	30,923	27,136	4,111,460	53,039.44	53,149

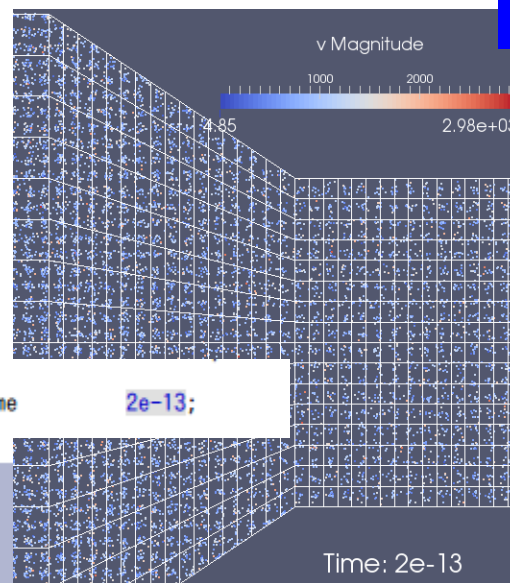
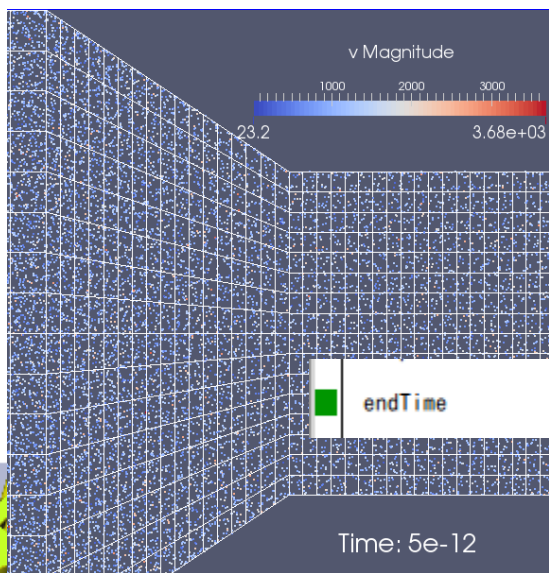
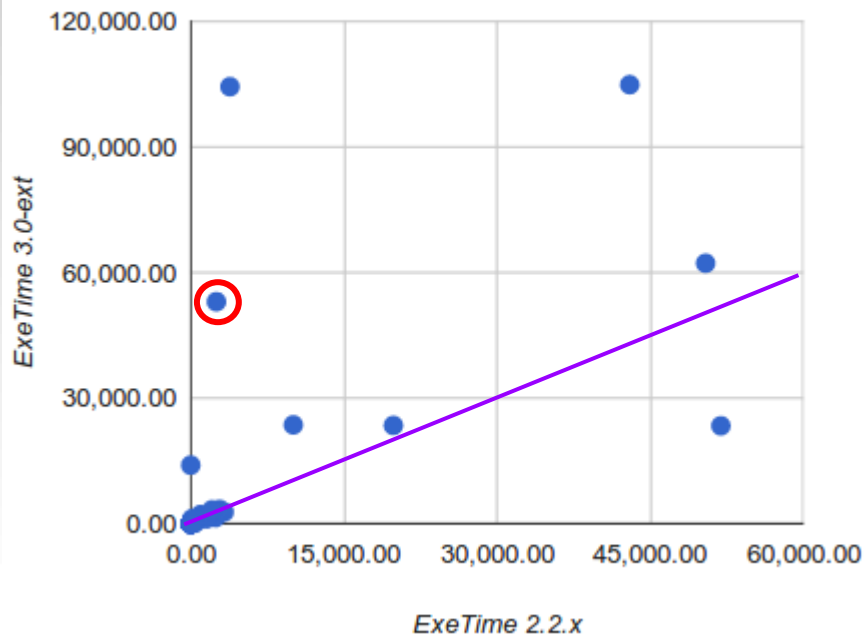
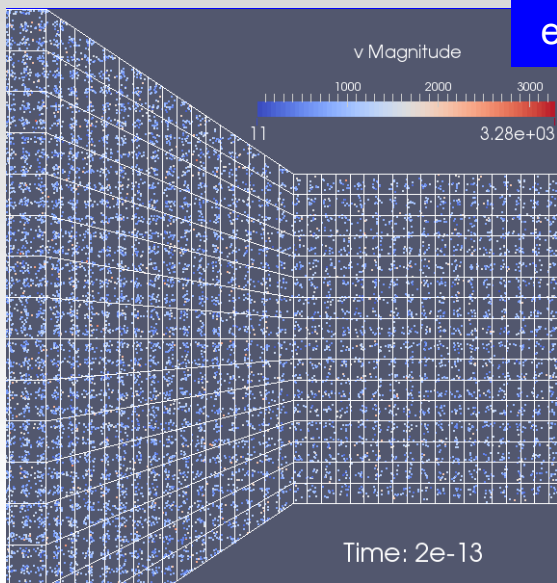

combustion	fireFoam		smallPoolFire2D	45,602	22,500	240,913	2,074.26	2,078
combustion	fireFoam		smallPoolFire2D	45,602	22,500	228,852	2,721.12	2,725

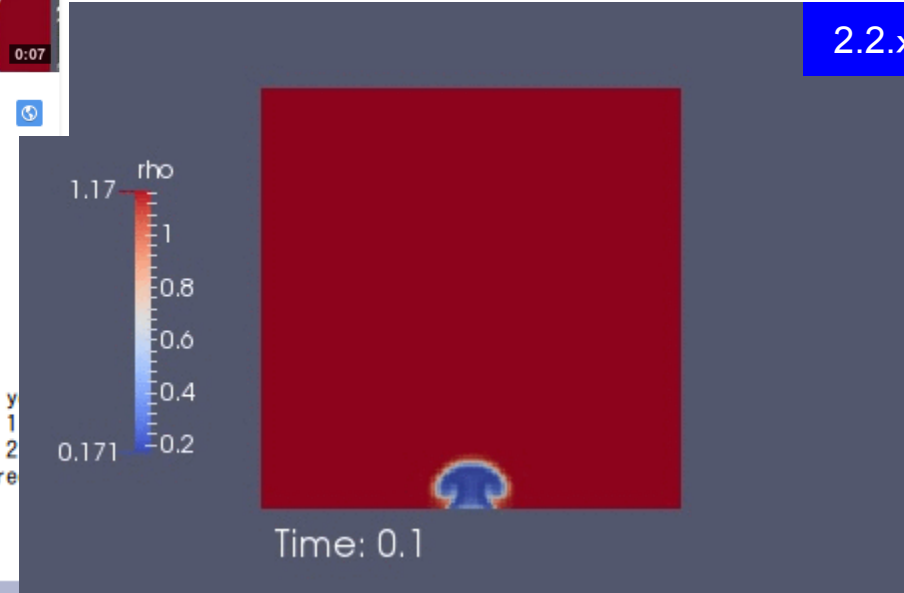
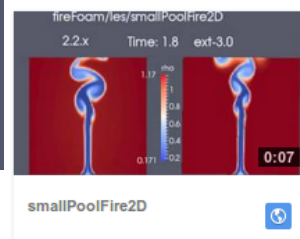
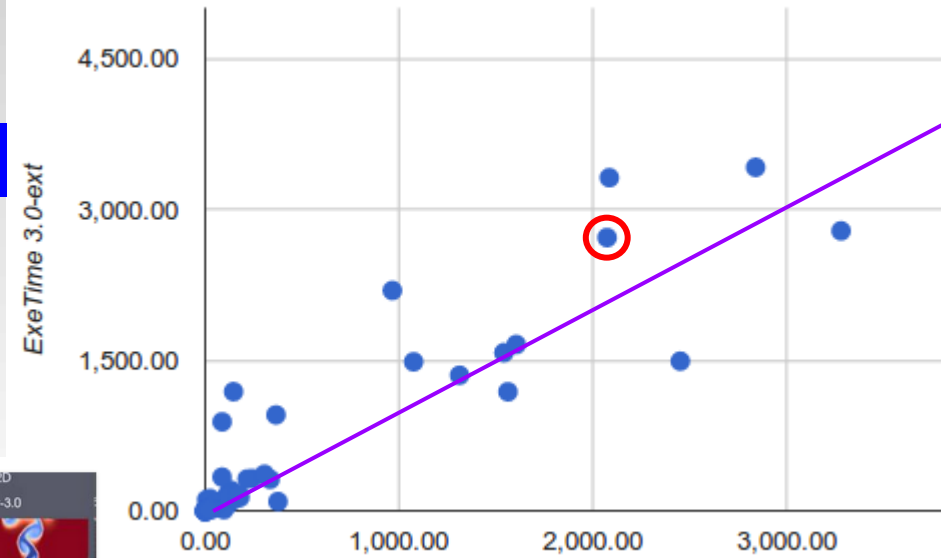
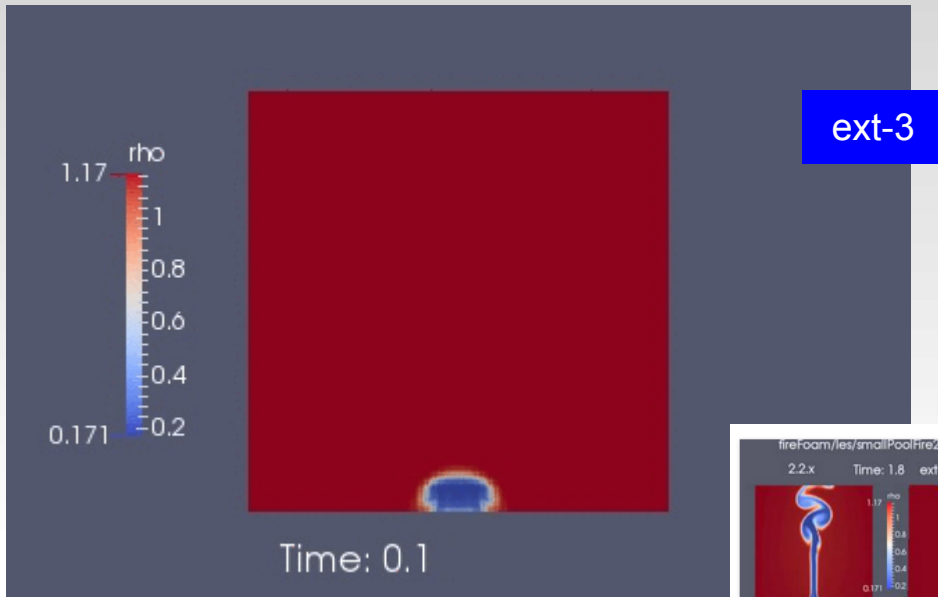

fvSolution

PISO

```
{
momentumPredictor yes;
nOuterCorrectors 1;
nCorrectors 2;
nNonOrthogonalCorrectors 0;
}
```

PIMPLE

```
{
momentumPredictor y
nOuterCorrectors 1
nCorrectors 2
nNonOrthogonalCorre
}
```

controlDict

```
maxCo 0.25;
```

```
maxCo 0.5;
```

compressible	sonicFoam	ras	nacaAirfoil	80,860	40,000	572,537	50,458.20	50,680
compressible	sonicFoam	ras	nacaAirfoil	80,860	40,000	535,820	62,232.70	62,328

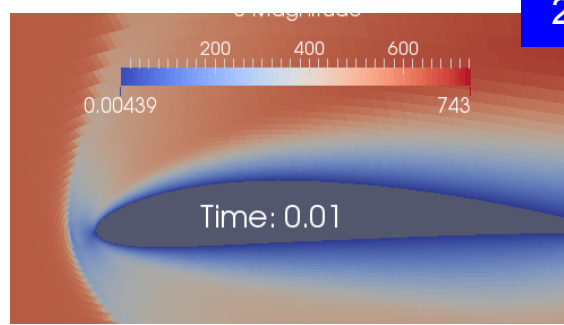
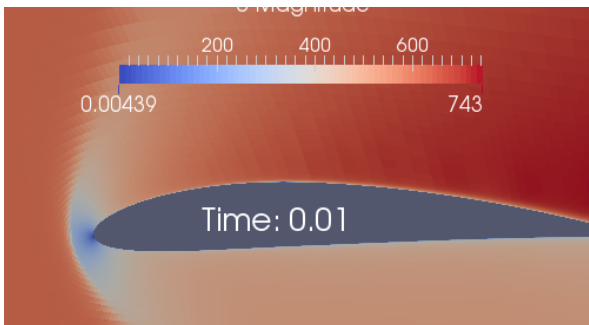
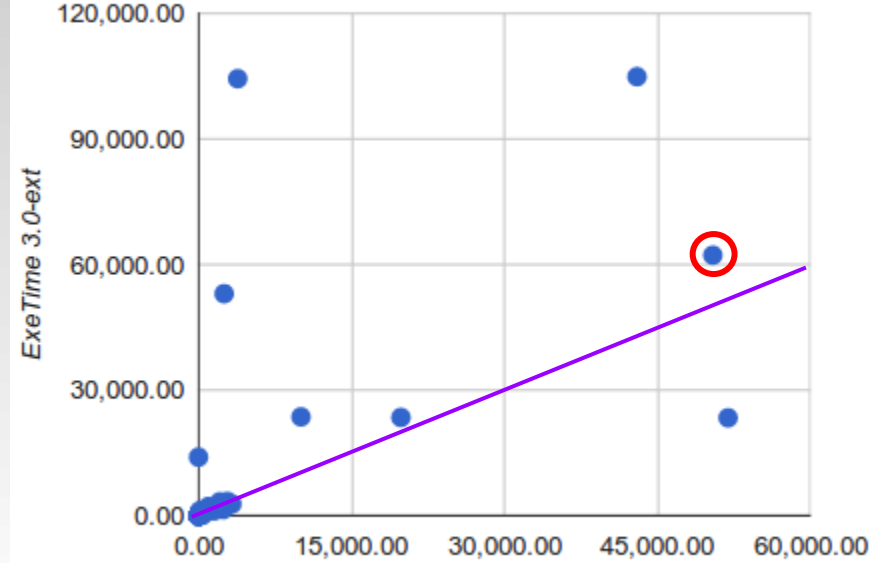
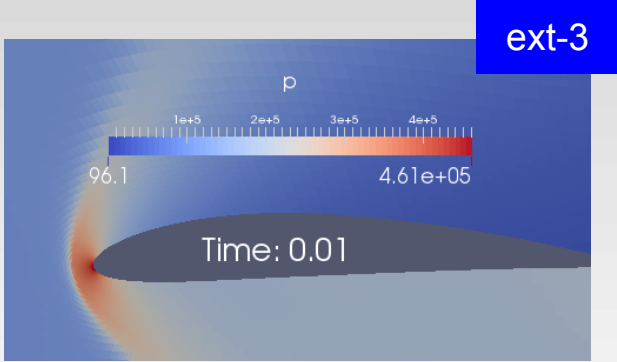

2.2.x

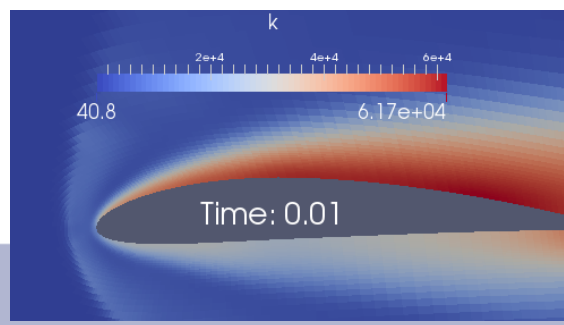
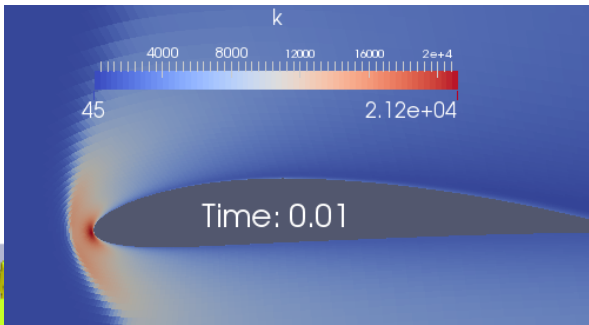
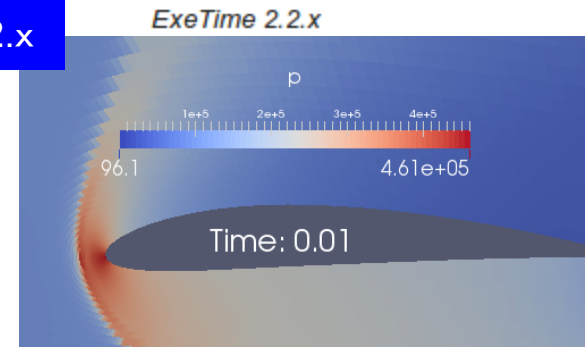

compressible	sonicFoam	ras	nacaAirfoil	80,860	40,000	572,537	50,458.20	50,680
compressible	sonicFoam	ras	nacaAirfoil	80,860	40,000	535,820	62,232.70	62,328

ext-3

2.2.x

fvSolution

```
PISO
{
  nCorrectors      2;
  nNonOrthogonalCorrectors 2;
}
```

```
PIMPLE
{
  nOuterCorrectors 1;
  nCorrectors_     2;
  nNonOrthogonalCorrectors 0;
}
```

thermophysicalProperties

```
thermoType ePsiThermo<pureMixture>
```

```
thermoType
{
  type          hePsiThermo;
  mixture       pureMixture;
  transport     const;
  thermo        hConst;
  equationOfState perfectGas;
  specie        specie;
  energy        sensibleInternalEnergy;
}
```

k

```
WALL10
{
  type          zeroGradient;
}
```

```
WALL10
{
  type          compressible::kqRWallFunction;
  value         uniform 1000;
}
```

mut

```
WALL10
{
  type          mutkWallFunction;
  Cmu           0.09;
  kappa         0.41;
  E             9.8;
  value         uniform 0;
}
```

```
WALL10
{
  type          mutLowReWallFunction;
  Cmu           0.09;
  kappa         0.41;
  E             9.8;
  value         uniform 0;
}
```

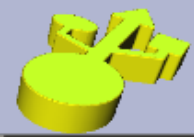

combustion	reactingFoam	ras	counterFlowFlame2D	8,282	4,000	8,341	122.62	123
combustion	reactingFoam	ras	counterFlowFlame2D	8,282	4,000	13,644	185.26	186

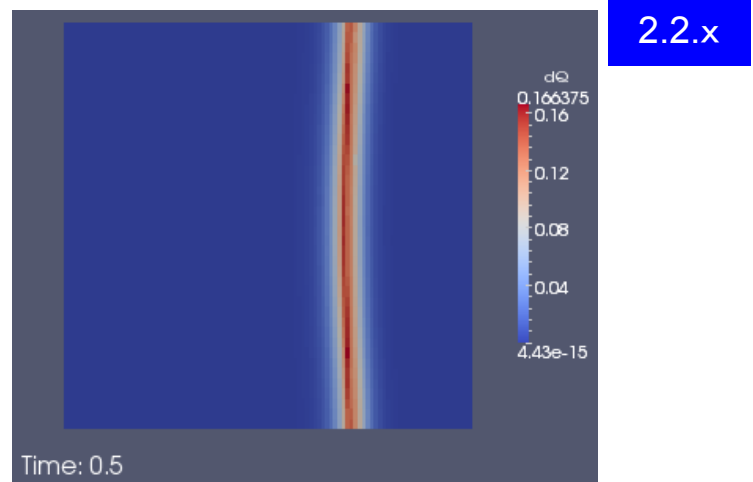
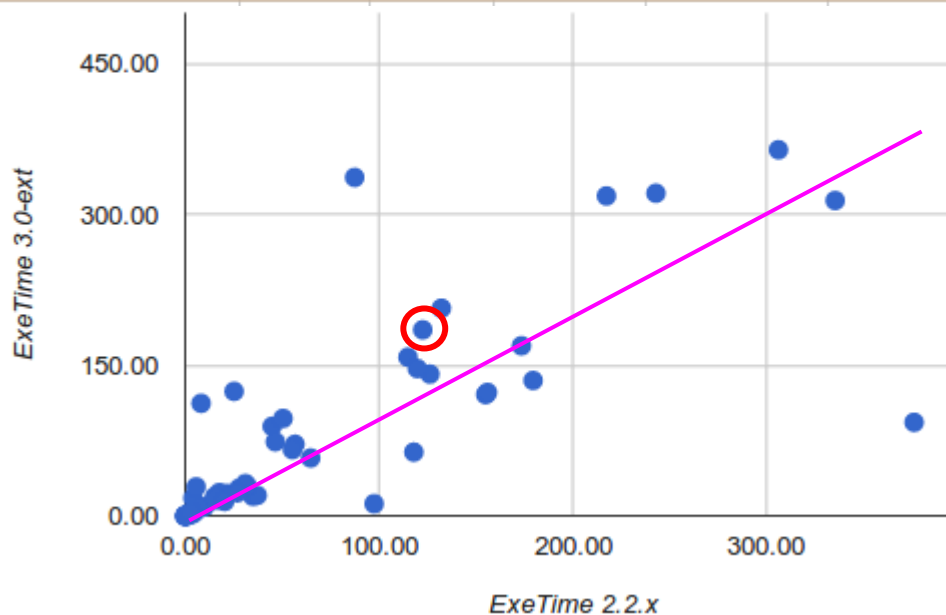
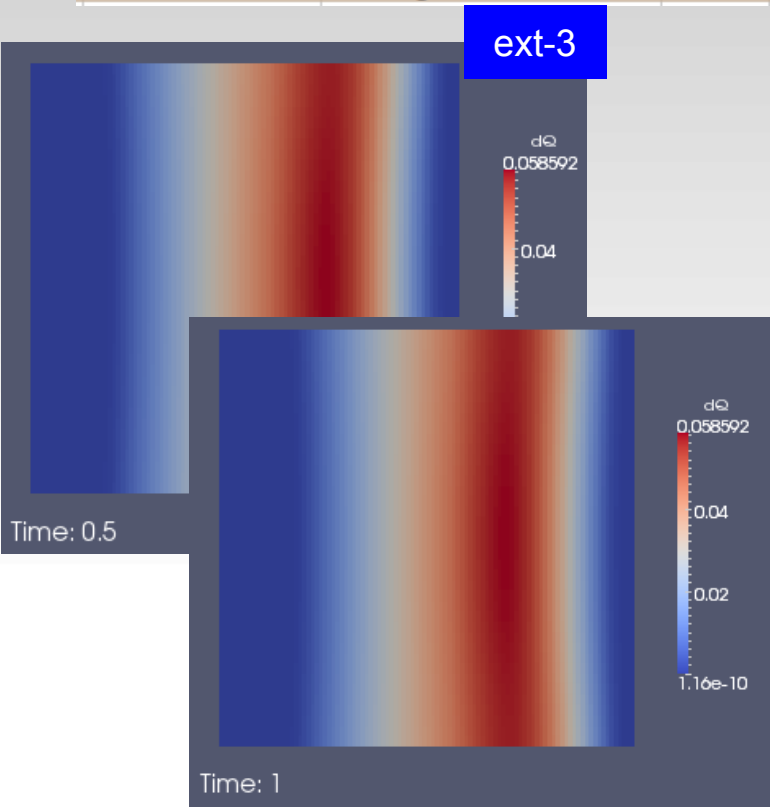

```

controlDict
{
    endTime 1.0;
    simulationType RASModel;
}

fvSolution
{
    PISO
    {
        nCorrectors 2;
        nNonOrthogonalCorrectors 0;
    }
}

controlDict
{
    endTime 0.5;
    simulationType laminar;
}

fvSolution
{
    PIMPLE
    {
        momentumPredictor no;
        nOuterCorrectors 1;
        nCorrectors 2;
        nNonOrthogonalCorrectors 0;
    }
}

```

				計算時間の比較				
multiphase	settlingFoam	ras	tank3D	23,044	19,166	307,693	19,861.50	19,885
multiphase	settlingFoam	ras	tank3D	23,044	19,166	296,100	23,475.60	23,505

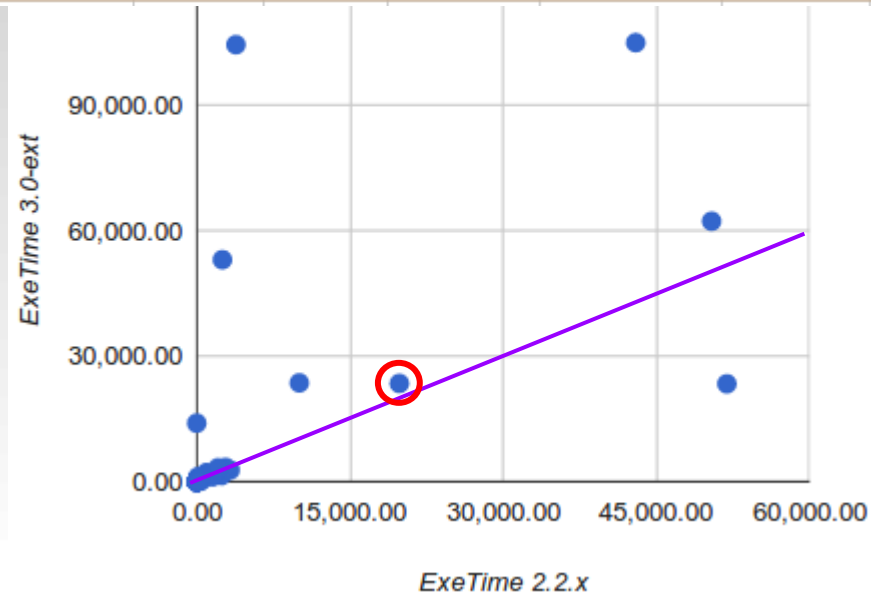
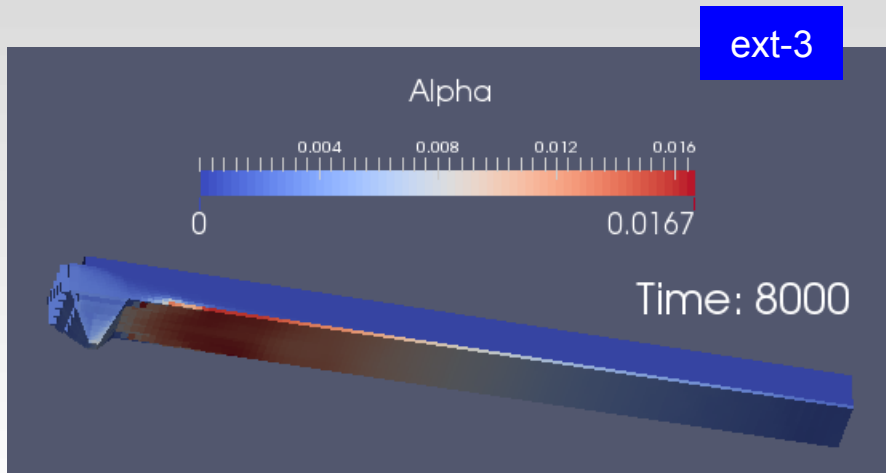

U

```

WALL6
{
  type translatingWallVelocity;
  U (-0.003 0 0);
  value uniform (-0.003 0 0);
}

```

```

WALL6
{
  type fixedValue;
  value uniform (-0.003 0 0);
}

```

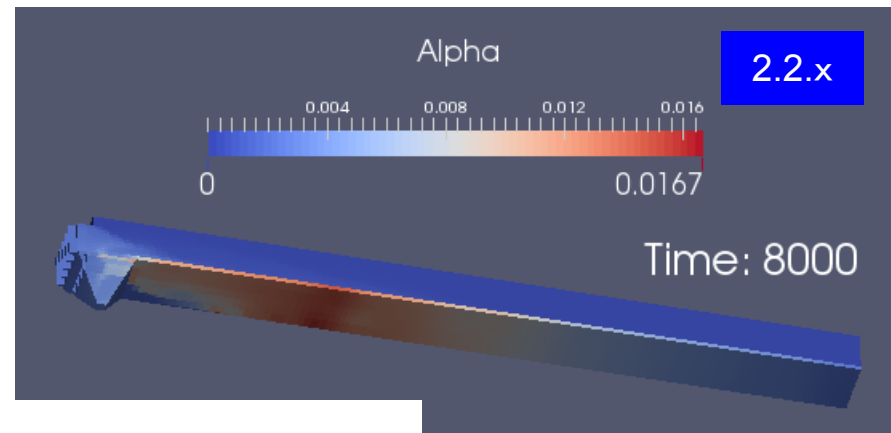

discreteMethods	dsmcFoam	supersonicCorner	83,509	77,760	228,853	3.23	3
discreteMethods	dsmcFoam	supersonicCorner	83,509	77,760	3,716,276	13,984.98	14,057

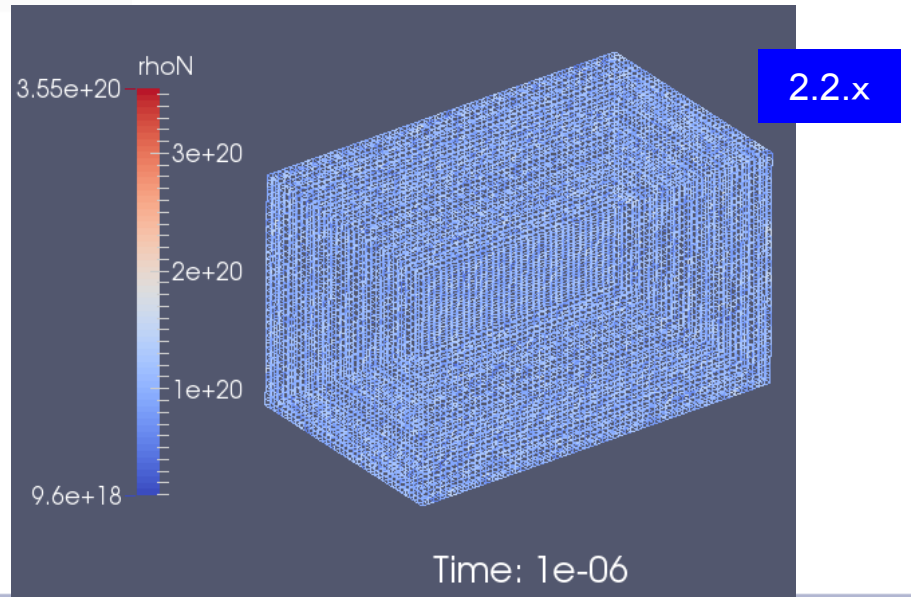
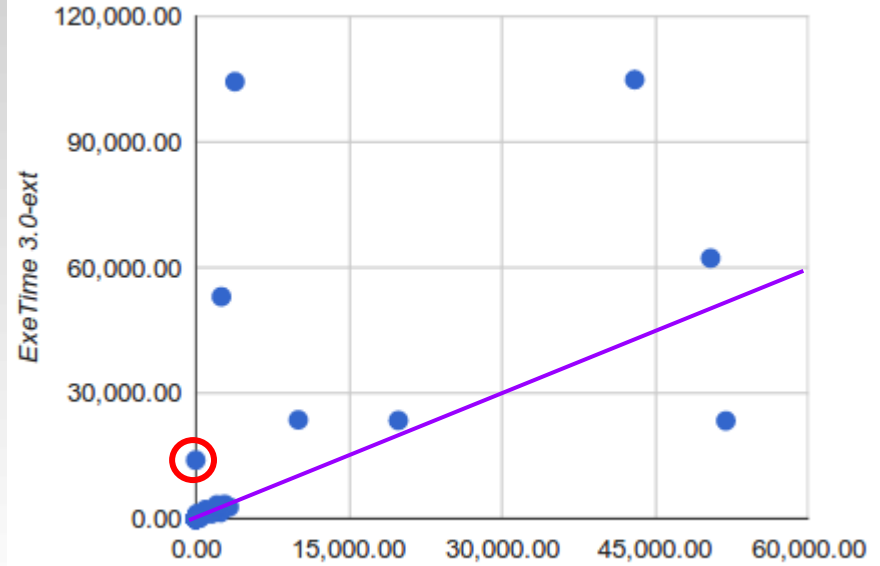
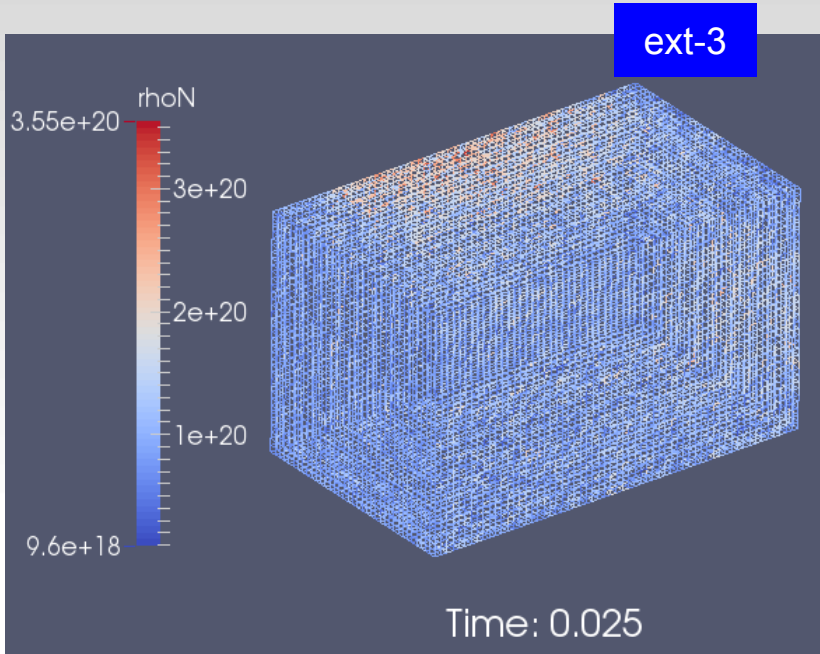

log

Small value (min(mag(rhoNMean))) [0 -3 0 0 0 0 0] 1e-300 found in rhoNMean field. Not calculating dsmcFields to avoid division by zero.

multiphase	compressibleInterFoam	laminar	depthCharge3D	1,056,321	1,024,000	8,534,724	10,055.45	10,094
multiphase	compressibleInterFoam	les	depthCharge3D	1,056,321	1,024,000	7,829,052	23,610.57	23,891

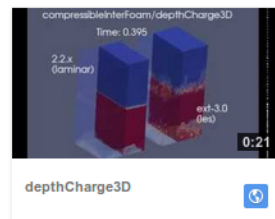
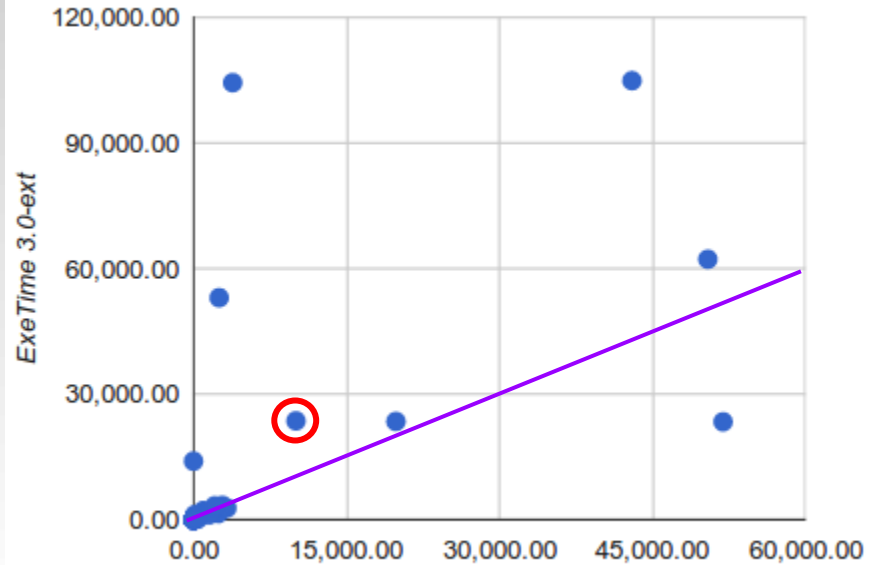
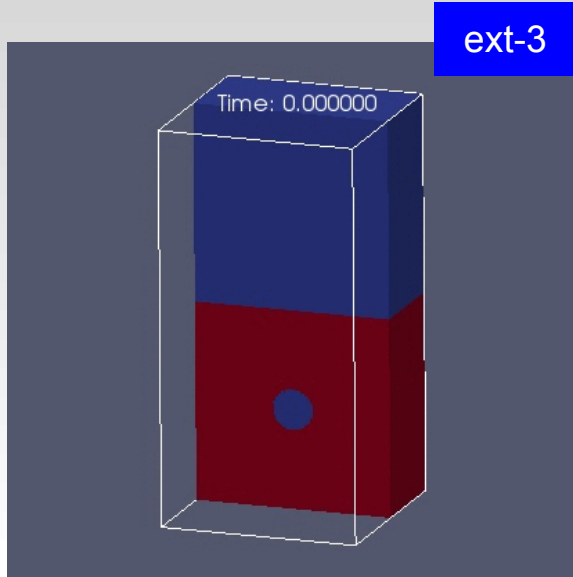

ExeTime 2.2.x

turbulenceProperties

```
simulationType LESModel;
```

```
simulationType laminar;
```

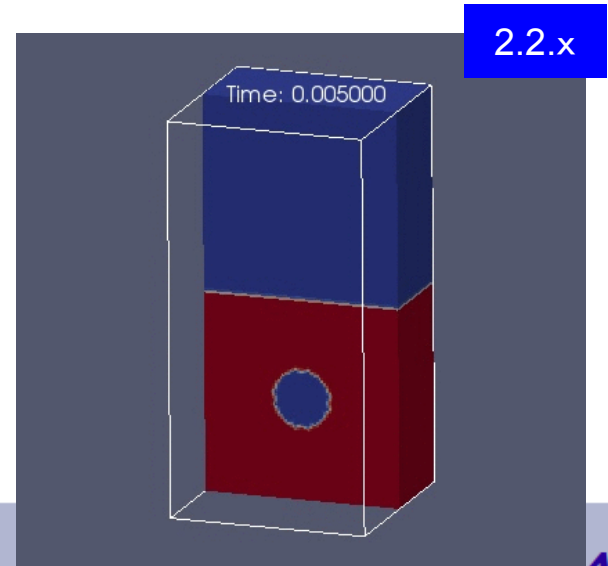

heatTransfer	buoyantSimpleFoam	hotRoom	4,851	4,000	3,577	5.71	5
heatTransfer	buoyantSimpleFoam	hotRoom	4,851	4,000	8,088	28.96	29

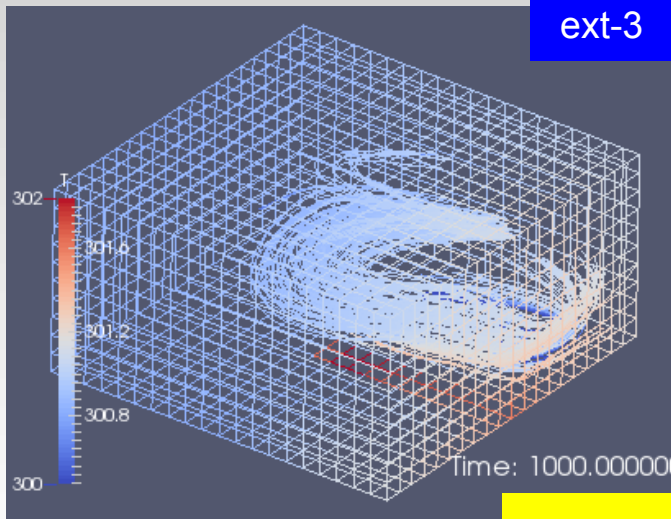

ext-3

非収束解

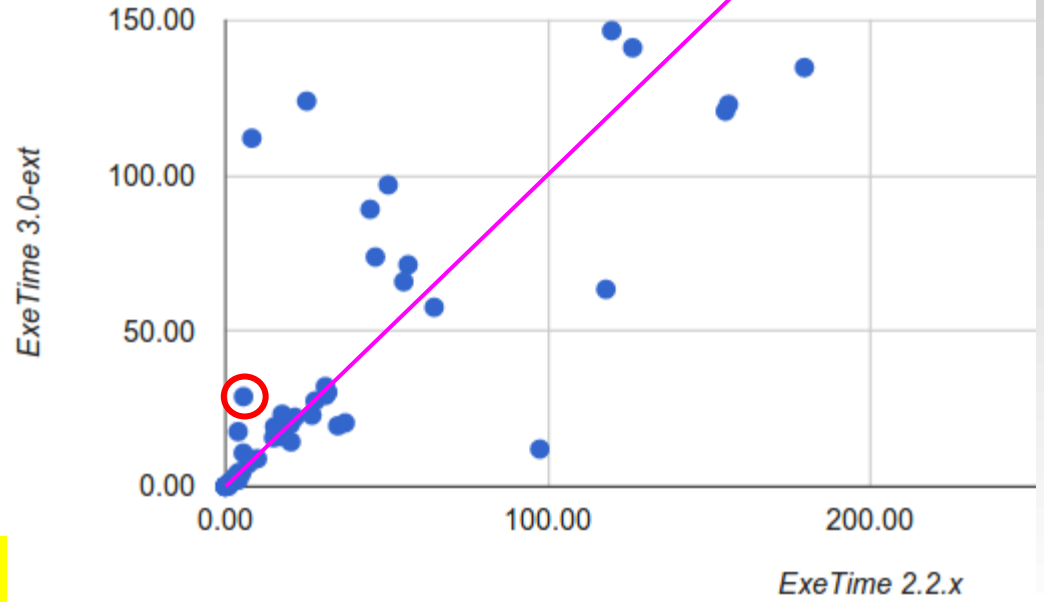

g

dimensions value [0 1 -2 0 0 0 0];
(0_0 -9.81);

dimensions value [0 1 -2 0 0 0 0];
(0 -9.81_0);

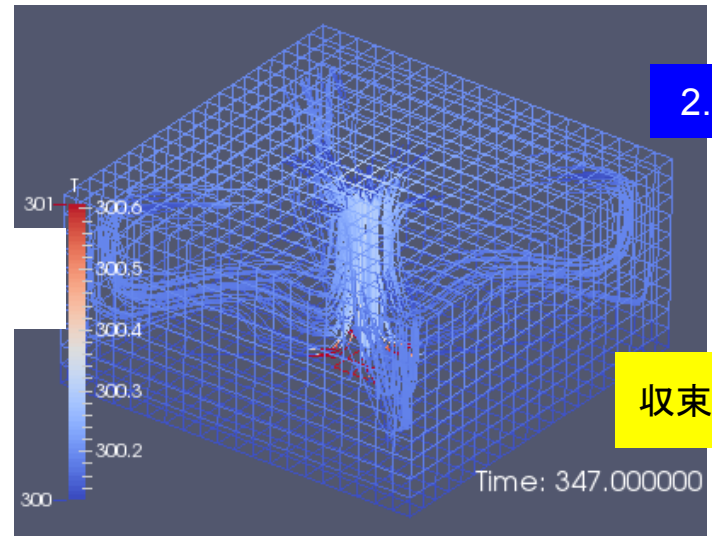

2.2.x

収束定常解

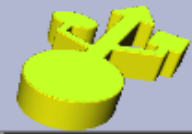

heatTransfer	chtMultiRegionSimpleFoam	snappyHexMesh	multiRegionHeater	3,751	3,000	11,329	97.56	98
heatTransfer	chtMultiRegionSimpleFoam	snappyHexMesh	multiRegionHeater	3,751	3,000	8,564	12.10	12

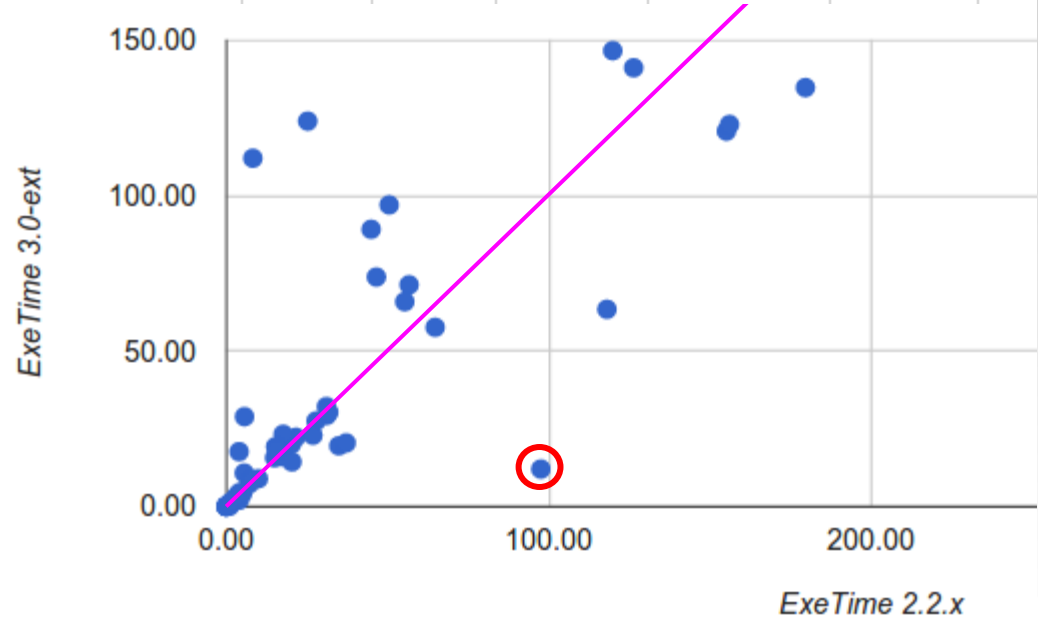
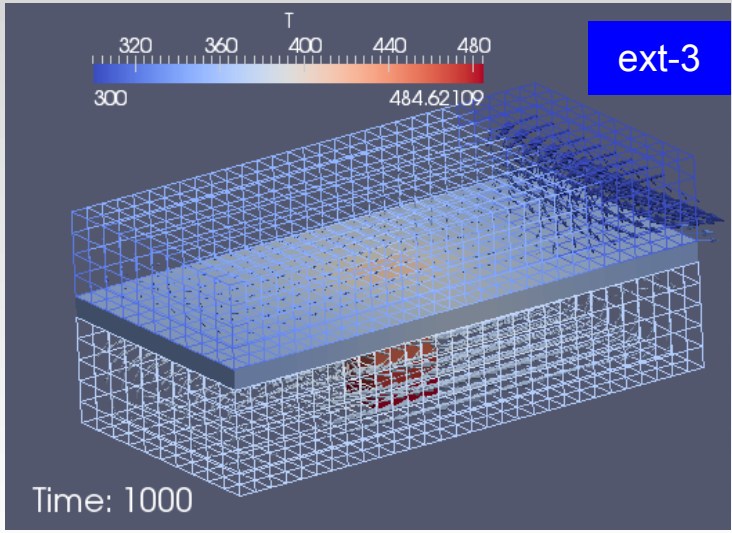

controlDict

```

endTime 1000;
endTime 3500;

```

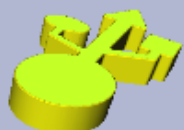
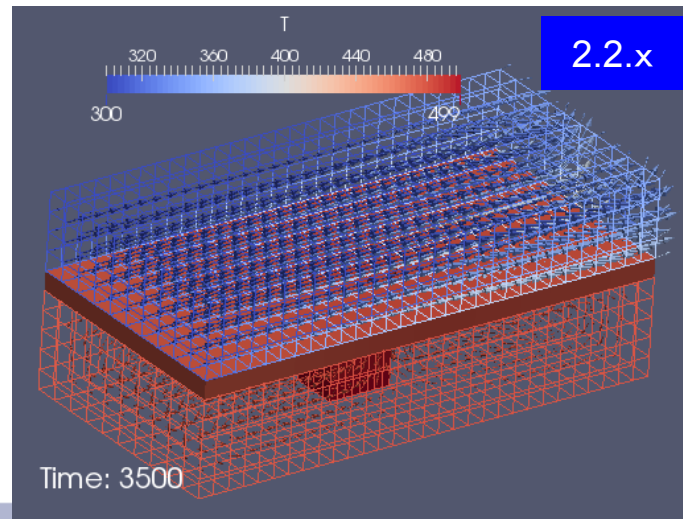

heatTransfer	chtMultiRegionSimpleFoam	snappyMultiRegionHeater	3,751	3,000	11,329	97.56	98
heatTransfer	chtMultiRegionSimpleFoam	multiRegionHeater	3,751	3,000	8,564	12.10	12

ext-3

2.2.x

controlDict

```

endTime 1000;
endTime 3500;

```

fvSchemes

```

laplacianSchemes
{
  default none;
  laplacian(muEff,U) Gauss linear limited_0.333;
  laplacian((rho*(1|A(U))),p) Gauss linear limited_0.333;
  laplacian(alphaEff,h) Gauss linear limited_0.333;
  laplacian(DkEff,k) Gauss linear limited_0.333;
  laplacian(DepsilonEff,epsilon) Gauss linear limited_0.333;
  laplacian(DREff,R) Gauss linear limited_0.333;
}

```

```

laplacianSchemes
{
  default none;
  laplacian(muEff,U) Gauss linear uncorrected;
  laplacian(Dp,p_rgh) Gauss linear uncorrected;
  laplacian(alphaEff,h) Gauss linear uncorrected;
  laplacian(DkEff,k) Gauss linear uncorrected;
  laplacian(DepsilonEff,epsilon) Gauss linear uncorrected;
  laplacian(DREff,R) Gauss linear uncorrected;
}

```

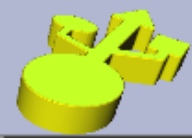

basic	potentialFoam		pitzDaily	25,012	12,225	3,433	0.23	0
basic	potentialFoam		pitzDaily	25,012	12,225	3,512	0.22	1

ext-3



2.2.x

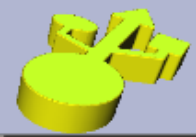

basic	scalarTransportFoam	pitzDaily	25,012	12,225	19,124	0.00	0
basic	scalarTransportFoam	pitzDaily	25,012	12,225	19,368		12

ext-3



2.2.x

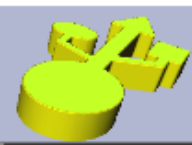

basic	potentialFoam	cylinder	4,222	2,000	8,204	0.06	9
basic	potentialFoam	cylinder	4,222	2,000	1,096	0.04	0

ext-3

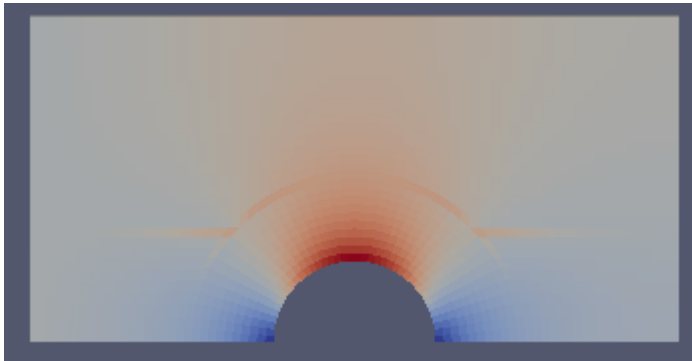

2.2.x

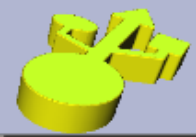
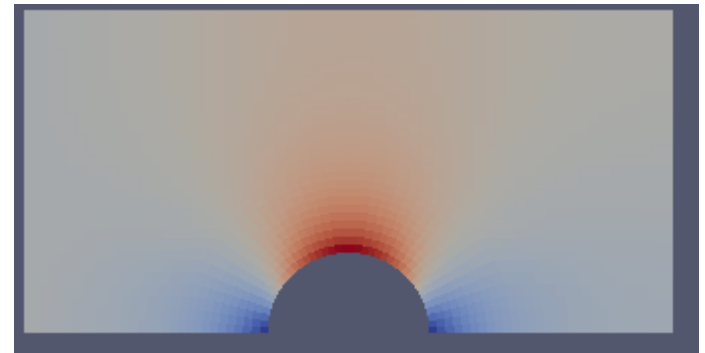

compressible	rhoCentralFoam	biconic25-55Run35	65,408	32,385	20,254	44.95	45
compressible	rhoCentralFoam	biconic25-55Run35	65,408	32,385	20,516	89.22	90

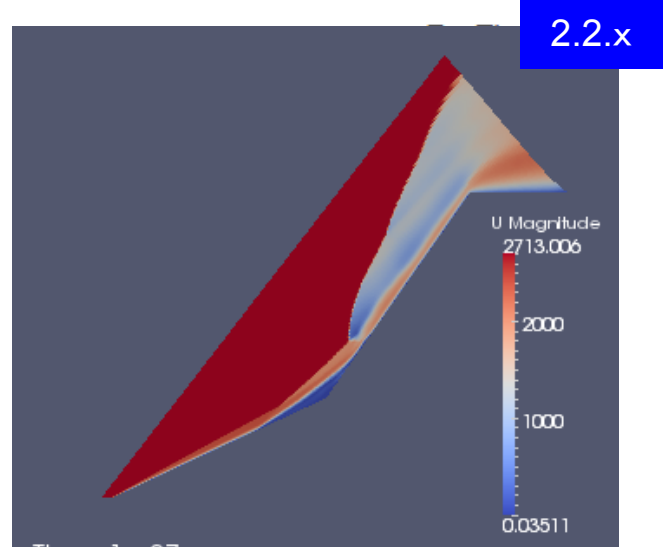
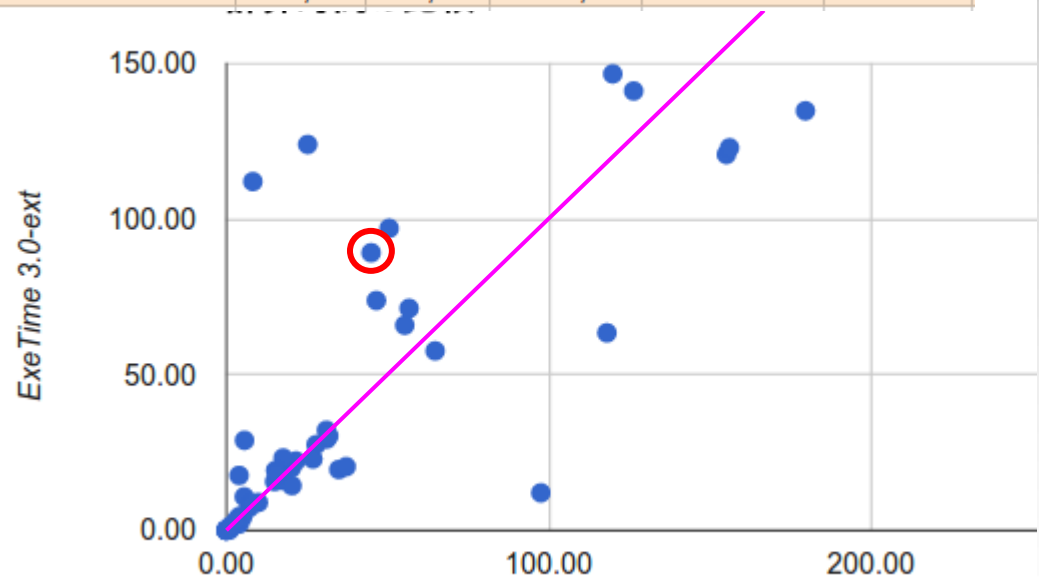
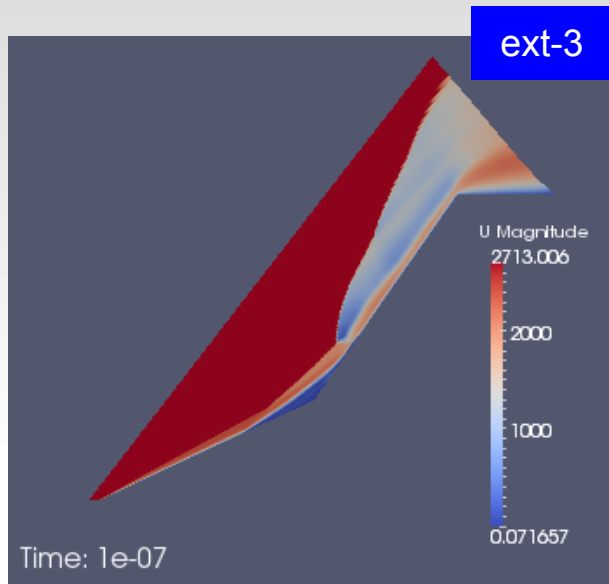

controlDict

maxCo 0.5; maxCo 0.3;

log

Mean and max Courant Numbers = 0.00129208663361523_0.497666942198304
 deltaT = 3.8945966221797e-10
 Time = 1e-07

Mean and max Courant Numbers = 0.00223270566925037_0.298004044513947
 deltaT = 7.08208844135878e-10
 Time = 1e-07

compressible	rhoCentralFoam		forwardStep	32,898	16,128	34,440	335.45	337 t
compressible	rhoCentralFoam		forwardStep	32,898	16,128	34,248	313.98	314 t

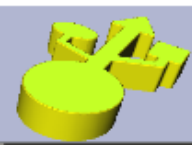
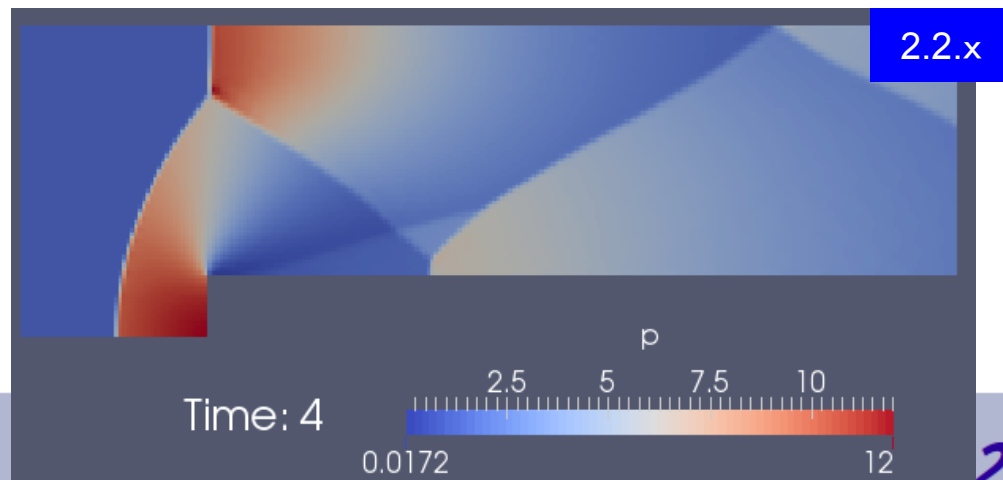
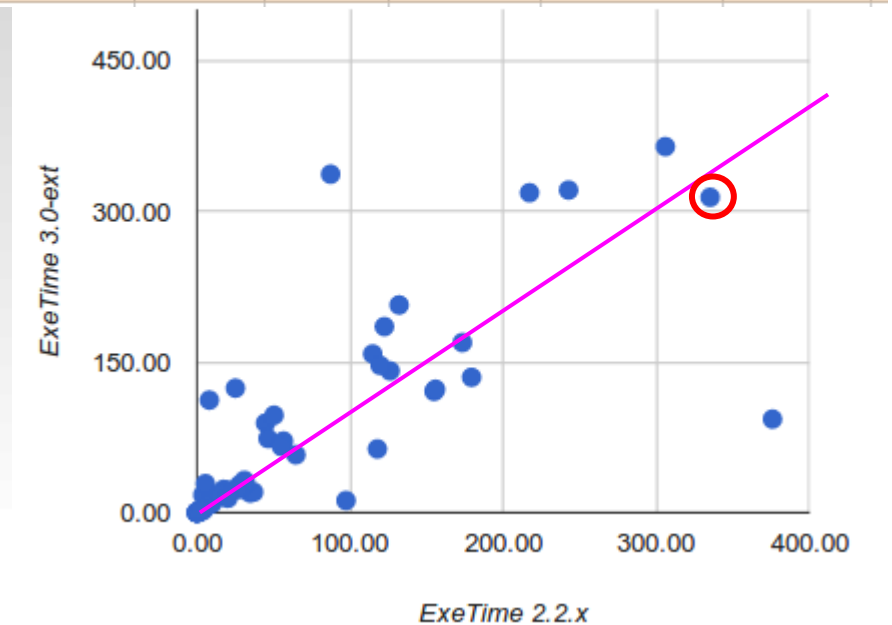
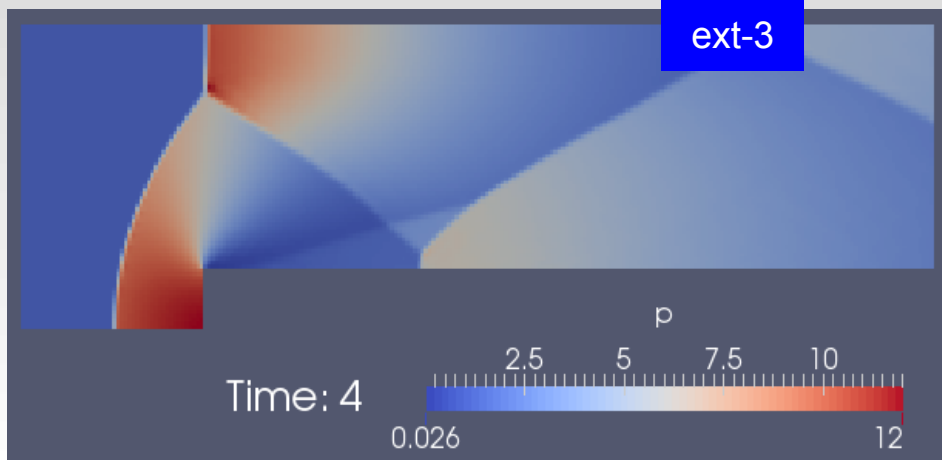

compressible	rhoCentralFoam	LadenburgJet60psi	2,501	1,200	1,353	8.28	8
compressible	rhoCentralFoam	LadenburgJet60psi	2,501	1,200	12,824	112.07	112

ext-3

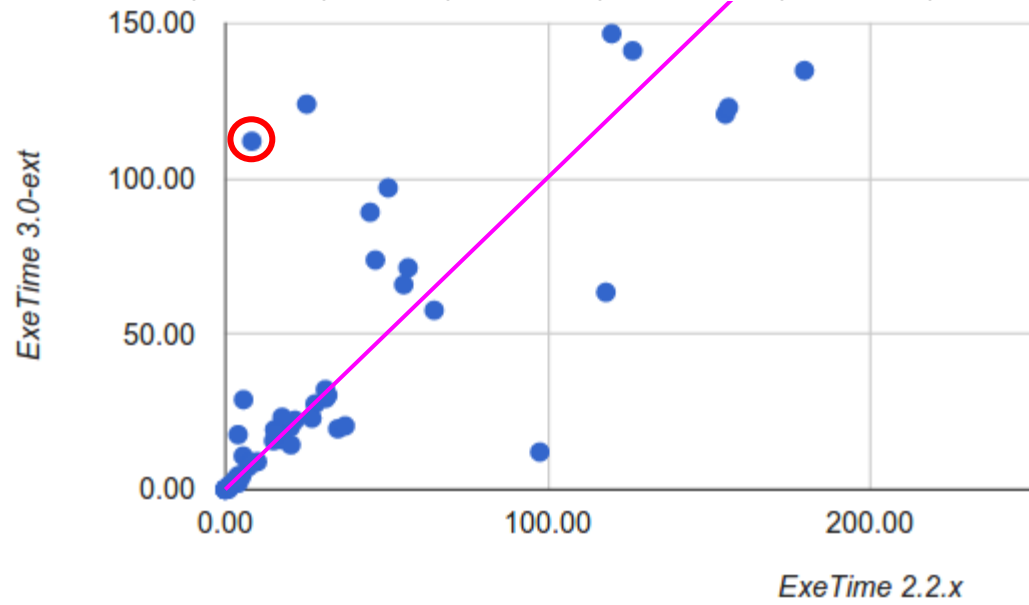
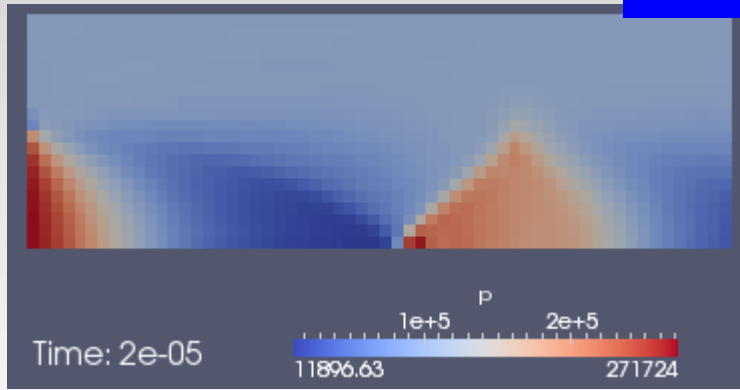

thermophysicalProperties

```
thermoType ePsiThermo<pureMixture<sutherl
```

```
thermoType
{
  type          hePsiThermo;
  mixture       pureMixture;
  transport     sutherland;
  thermo        hConst;
  equationOfState perfectGas;
  specie        specie;
  energy        sensibleInternalE
```

2.2.x

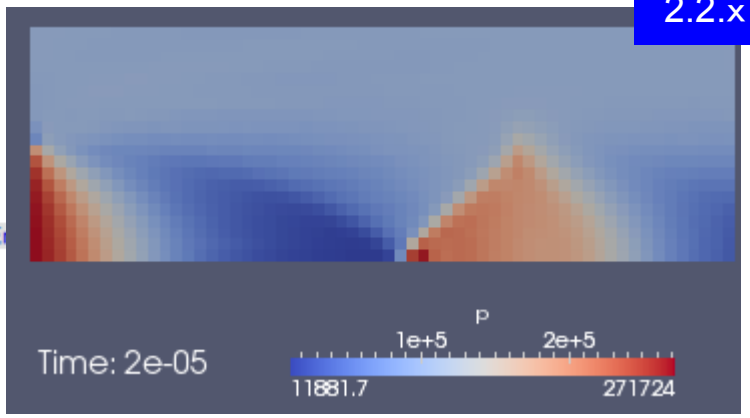

log

Mean and max Courant Numbers = 0.000849907507894318_0.49940035309
 deltaT = 1.75909007221821e-09
 Time = 2e-05

Mean and max Courant Numbers = 0.013182994636908_0.49958406640848
 deltaT = 2.72850501083426e-08
 Time = 2e-05

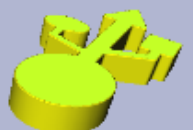

compressible	rhoCentralFoam		obliqueShock	3,782	1,800	3,300	20.25	20
compressible	rhoCentralFoam		obliqueShock	3,782	1,800	3,428	20.10	20

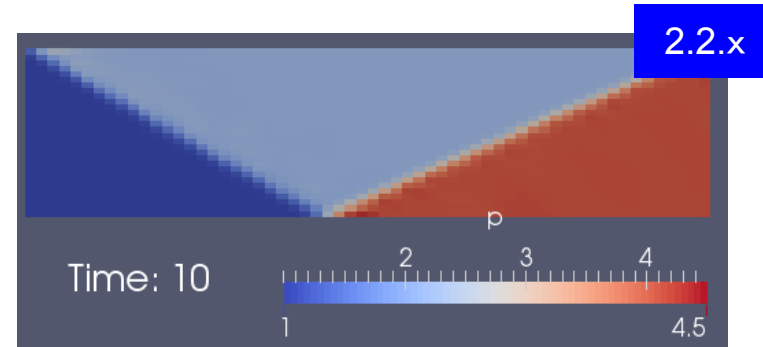
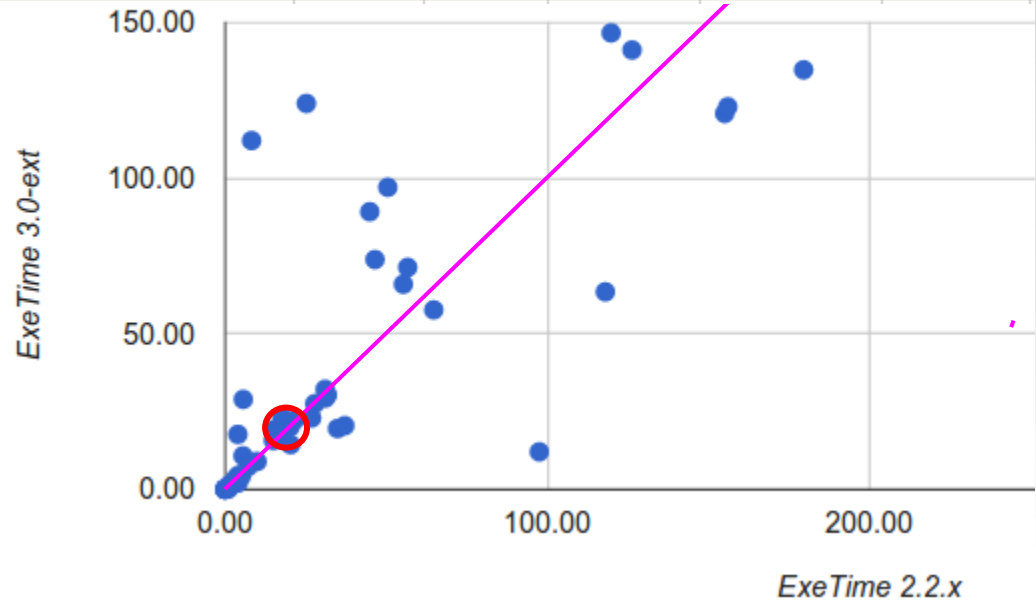
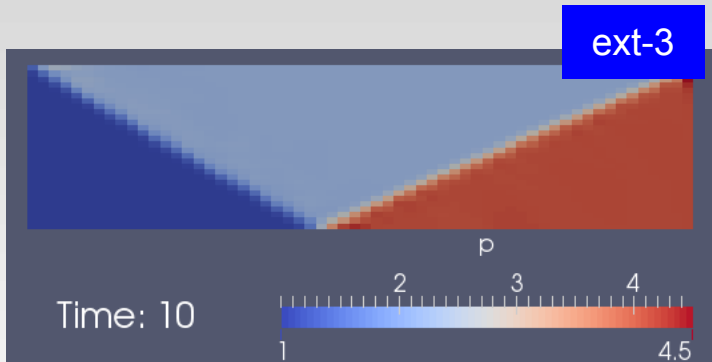

thermophysicalProperties

```
thermoType_____ePsiThermo<pureMixture<constTrans
```

```
thermoType
{
  type          hePsiThermo;
  mixture       pureMixture;
  transport     const;
  thermo        hConst;
  equationOfState perfectGas;
  specie        specie;
  energy        sensibleInternalEnergy;
}
```

combustion	XiFoam	ras	moriyoshiHomogeneous	5,112	2,450	22,812	34.94	36
combustion	XiFoam	ras	moriyoshiHomogeneous	5,112	2,450	22,728	19.57	20
combustion	XiFoam	ras	moriyoshiHomogeneousP	5,112	2,450	23,848	37.22	37
combustion	XiFoam	ras	moriyoshiHomogeneousP	5,112	2,450	23,316	20.50	20

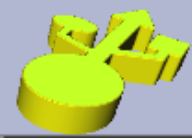
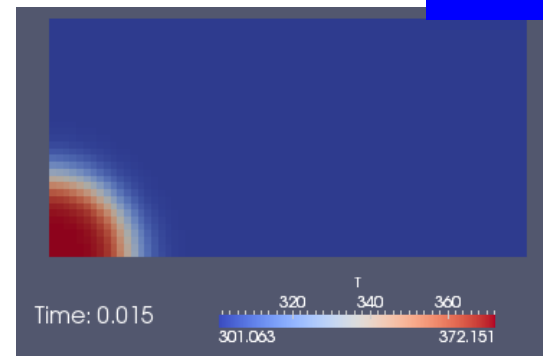
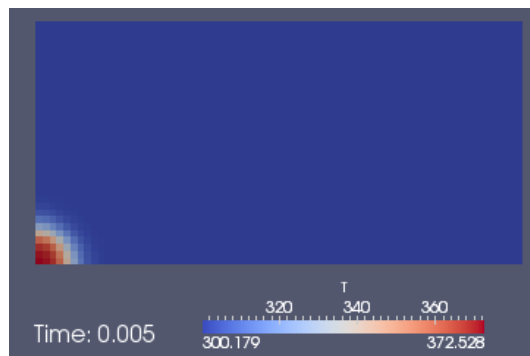
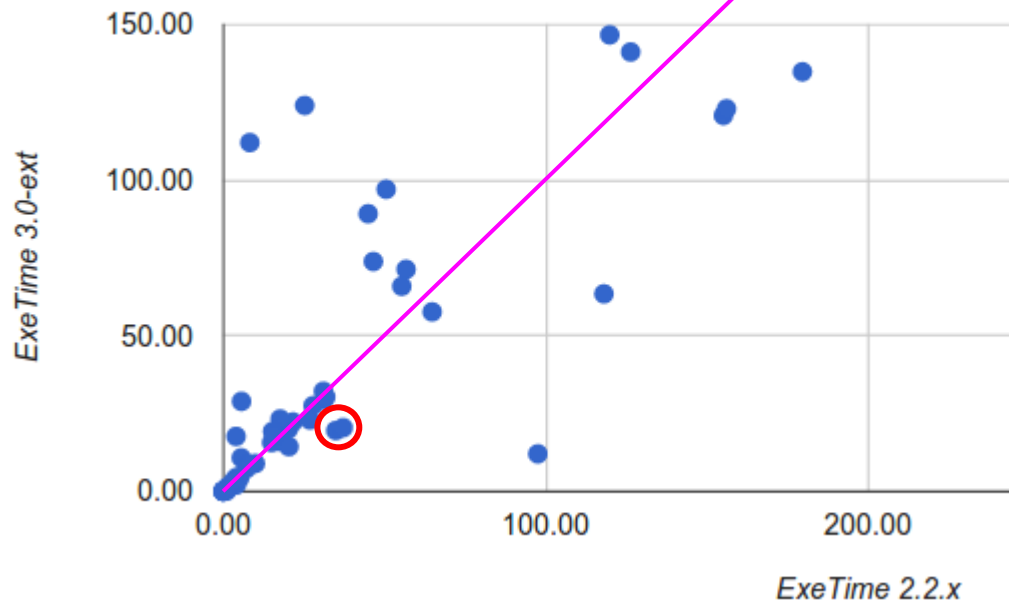
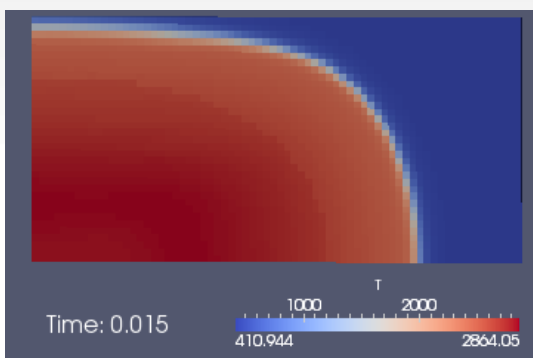
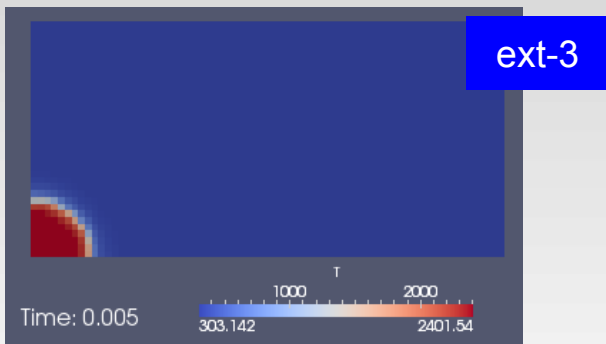

combustion	XiFoam	ras	moriyoshiHomogeneous	5,112	2,450	22,812	34.94	36
combustion	XiFoam	ras	moriyoshiHomogeneous	5,112	2,450	22,728	19.57	20
combustion	XiFoam	ras	moriyoshiHomogeneousP	5,112	2,450	23,848	37.22	37
combustion	XiFoam	ras	moriyoshiHomogeneousP	5,112	2,450	23,316	20.50	20

ext-3

2.2.x

thermophysicalProperties

```
thermoType_____hhuMixtureThermo<hc
```

```
thermoType
{
  type          heheuPsiThermo;
  mixture       homogeneousMixt
  transport     suther land;
  thermo        janaf;
  equationOfState perfectGas;
  specie        specie;
  energy        absoluteEnthalp
}
```

fvSolution

```
PISO
{
  nCorrectors_____ 2;
  nNonOrthogonalCorrectors 0;
  momentumPredictor yes;
}
```

```
PIMPLE
{
  nOuterCorrectors 2;
  nCorrectors_____ 1;
  nNonOrthogonalCorrectors 0;
}
```